

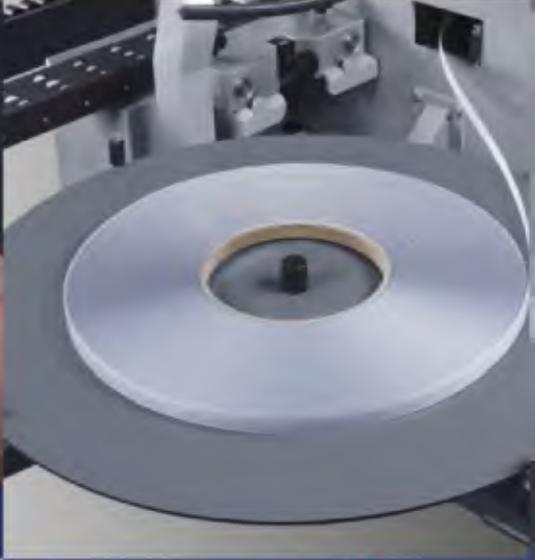

FORMAT®

IN A CLASS OF ITS OWN

Woodworking machines

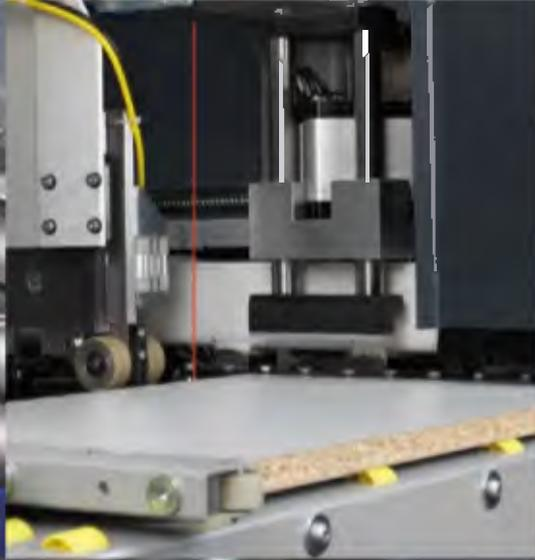



Welcome to FORMAT-4!

It feels like it was only yesterday that the idea of the premium brand Format-4 came about. Since 2001, we have continuously set new standards in the market and have quickly become one of the major players in the high-end segment.

Under the motto, "Everything from a single supplier", we offer individual products, customised machine configurations, expert advice, solution-oriented customer service, consistent innovation and traditional values all combined to provide a perfectly balanced complete top class package.

We will continue to follow our path into the future without making compromises, just as we have always done and with passion, conviction and courage to innovate we will continue to offer our customers, the exact machine that they require.

Countless woodworking companies worldwide already rely on our Austrian profit generator and benefit from the Format-4 complete package for perfect woodworking.

Visit our website or at a showroom near to you.

Discover more about the range on offer from the Felder Group, test our machines and find the ideal solution for your individual requirements of perfect woodworking.

A handwritten signature in blue ink that reads "Hansjörg Felder". The signature is written in a cursive, flowing style.

Prof. h.c. Ing. Hansjörg Felder



Proven

TRADITION

and consistent

INNOVATION

for

PERFECTION

in woodworking

18

Panel Saws



18 kappa 550



18 kappa 550 x-motion



18 kappa 550 e-motion



41 kappa 400



41 kappa 400 x-motion

59

Planers



59 plan 51L



67 exact 63



67 exact 51



77 dual 51

89

Spindle Moulders



90 profil 45 Z



90 profil 45 Z x-motion



92 profil 45 M



92 profil 45 M x-motion

108

CNC Machining Centres and handling systems



118 c-express 920 classic



124 profit H200



124 profit H300



134 profit H350



134 profit H500



154 profit H08



160 profit H10



180 tempora 60.08
x-motion plus



180 tempora 60.12
x-motion plus/e-motion

Edgebanders
and return systems

180



193 U-motion professional

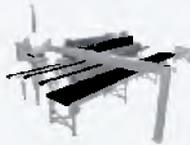

193 U-motion classic



197 finish 1102/1302



204 finish 1350 classic/gloss

Wide Belt Sanders

197

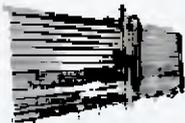

210 kappa V60



214 kappa automatic
60/80/100

Beam saws
and handling systems

209



221 V-motion



225 L-motion



229 HVP Typ 1/2/3/4

Veneer Presses

229



FORMAT-4 - our quality is your success!

The quality of our products determines the success of our customers. For that reason we are always looking to work together and get feedback from woodworkers in workshops, business and industry. This continuous exchange of information makes it possible for us to take into consideration the requirements of the machine users when we are developing new machine concepts, ensuring the competitiveness of our customers.

The most up-to-date manufacturing technology and strict production standards ensure excellent precision and the best processing quality. Our own in-house research and development department, numerous international patents and groundbreaking solutions ensures that we retain our leading developmental advantage.

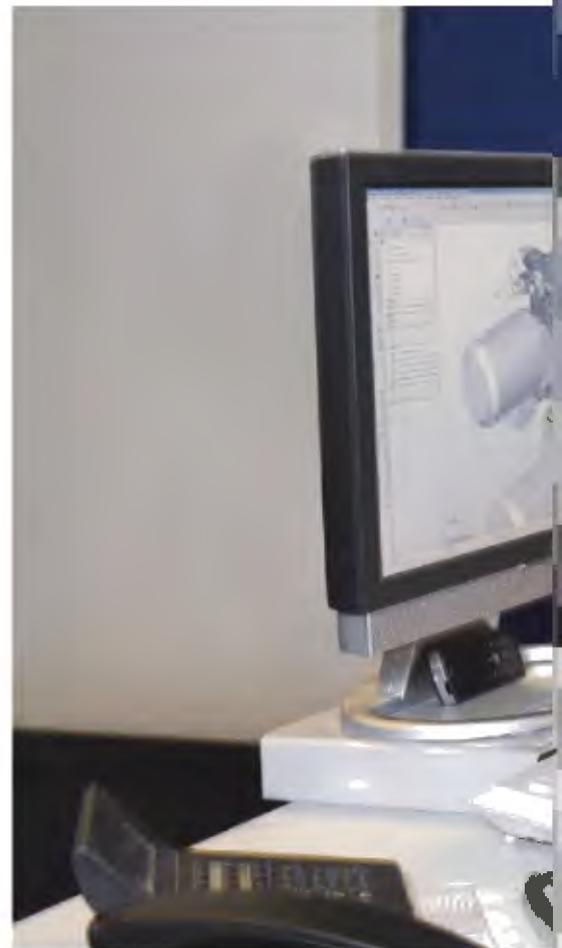

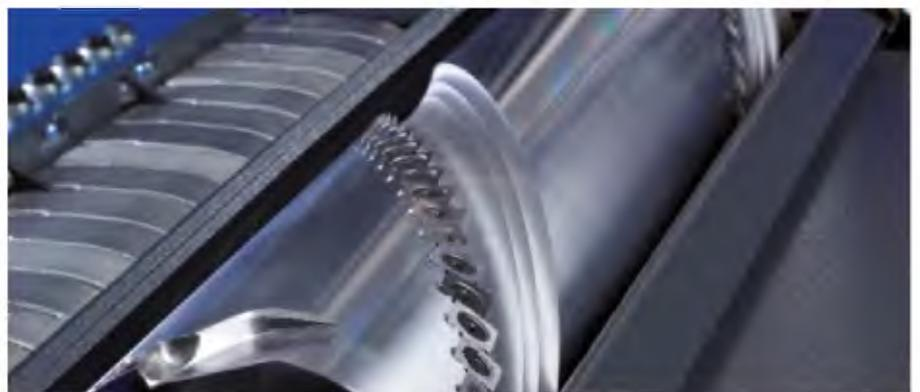



FORMAT-4 showrooms - discover a whole world of woodworking products!

With numerous sales and service centres, we are always close at hand. Competent technical advisers are on hand to guide you through the the full range of Format-4 products and to help you find the ideal machine that you require. Whether it is new machine launches, tools and accessories or a tested second hand machine - our range on offer will impress. Visit our showrooms and test our new machines first hand experiencing the numerous innovative new developments for yourself.







The FORMAT-4 service network - always there for you!

The continuous availability of modern woodworking machines is a significant influencing factor on the productivity and profitability of a company. The Format-4 service network ensures the operational readiness of your machines and guarantees constant precision.

With the Format-4 service network you can obtain individual all-round service to achieve perfect woodworking results right from the start. Excellent advice, immediate help and on-site service, continuous availability of machines, less down-time, optimal value retention and low subsequent costs - our service for your profit.

We have been focused on the development, production and sales of high quality woodworking machines for over 50 years. Today Felder Group woodworking machines are among the best selling worldwide.

Specially trained service personnel are always available to provide specialised on-site service for you. If the matter is urgent you can call our hotline centre for straightforward immediate help.

FORMAT.



FORMAT-4, the right decision!

Individual solutions for individual requirements

Each and every Format-4 woodworking machine is custom built to your requirements. We will strive to meet your every need when configuring your machine.

You can rely on our woodworking machines

Outstanding results, innovative developments and impeccable quality standards put Format-4 woodworking machines in a class of their own. Decision criteria such as stability, functionality and durability are standard characteristics of our machines.

Quality from Austria

With impressive detailed solutions, numerous innovations and patents, highest levels of user comfort and perfect precision, FORMAT-4 offers uncompromised expertise for the highest of requirements. Cutting edge manufacturing, innovative production machinery as well as constant quality control processes guarantee the quality, precision and reliability of your woodworking machinery.

Advice that you can rely on

Individual support begins at Format-4 long before the purchase decision is made. After a systematic requirement analysis, the configuration of tailor-made product solutions for the customer can be carried out at one of our technology centres or showrooms. By simulating the customer's production, the customer can test several different machine configurations ensuring that they find the perfect solution for their individual requirement.



Always working for you: The FORMAT-4 Service team

Specially trained technicians carry out the delivery, installation, commissioning and the initial machine configurations. This ensures that your machine can be used productively from the very first day of use.

In the next link of the Format-4 service chain, our customers profit from tailored inspection and maintenance packages and a competent service hotline offering immediate support. Numerous Format-4 service centres ensure that a Format-4 technician is close at hand and spare parts are also readily available. Customers with computer controlled machinery also have the possibility of getting their employees professionally trained on a range of software and machinery courses.



FORMAT-4 customers - driven by conviction and passion!

Every day woodworkers all over the world decide on a woodworking machine from the Felder Group. With this decision they become not just a customer but an ambassador for perfect woodworking.



"A valuable partner in every workshop! With the Tyrolean quality products from the Felder Group, you experience the local workmanship with every working step."

Adi Egger, Master Carpenter, Tyrol



"The efficiency of the machines and the significant increased productivity has allowed us to diversify our business and offer nothing other than the best. Felder have been great, even though we are quite far away it has never been a problem and the service is amazing!"

Duncans of Grantown, Grantown on Spey, UK



"From the first meeting through to the installation of the machine and the first processes and even with the correct choice of tools, we were looked after by competent Format-4 expert advisers and technicians. The advantage of the machine and the software coming from the same supplier, is that no excuses can be given: For optimum productivity CNC and software must work together smoothly!"

Schreinerei Epp, Carpenters, Germany

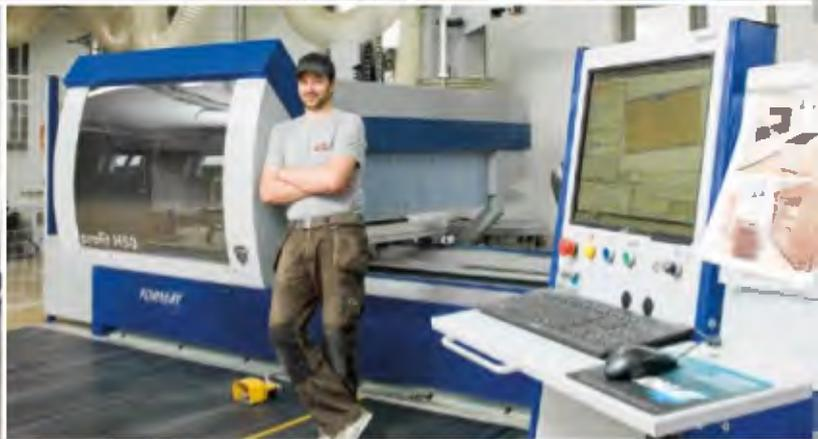

Visit us online and discover more about:

- Machines
- Videos
- Current promotions
- Tooling and accessories
- All technical information

www.format-4.com



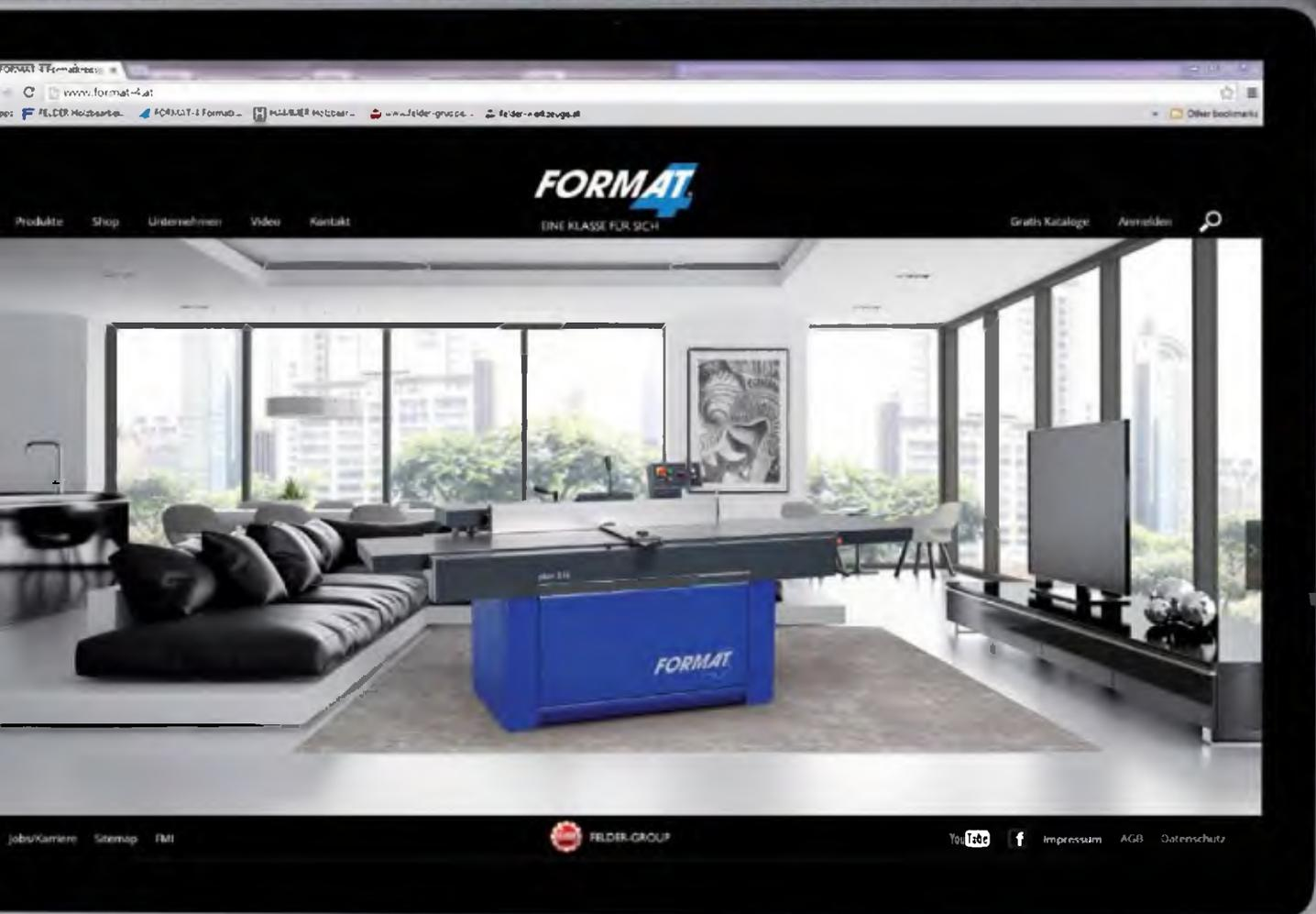
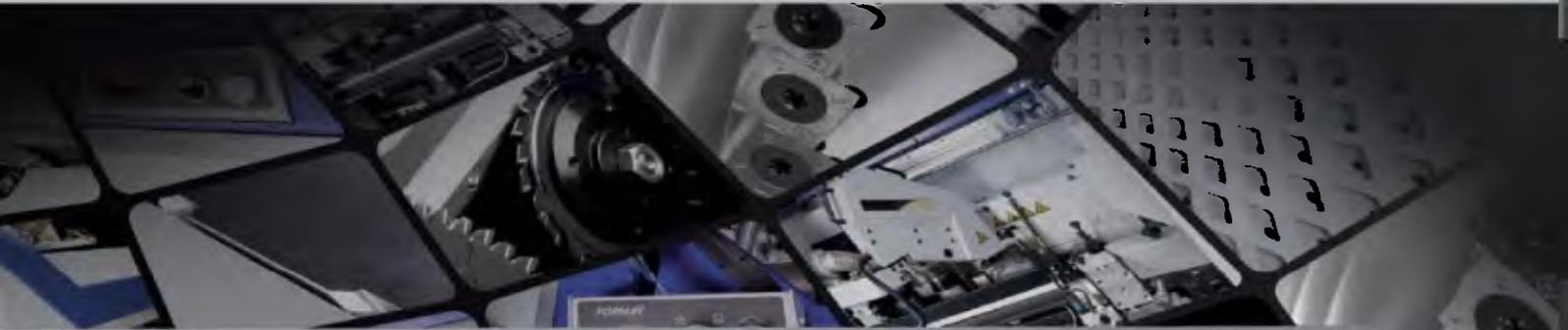

FORMAT[®]

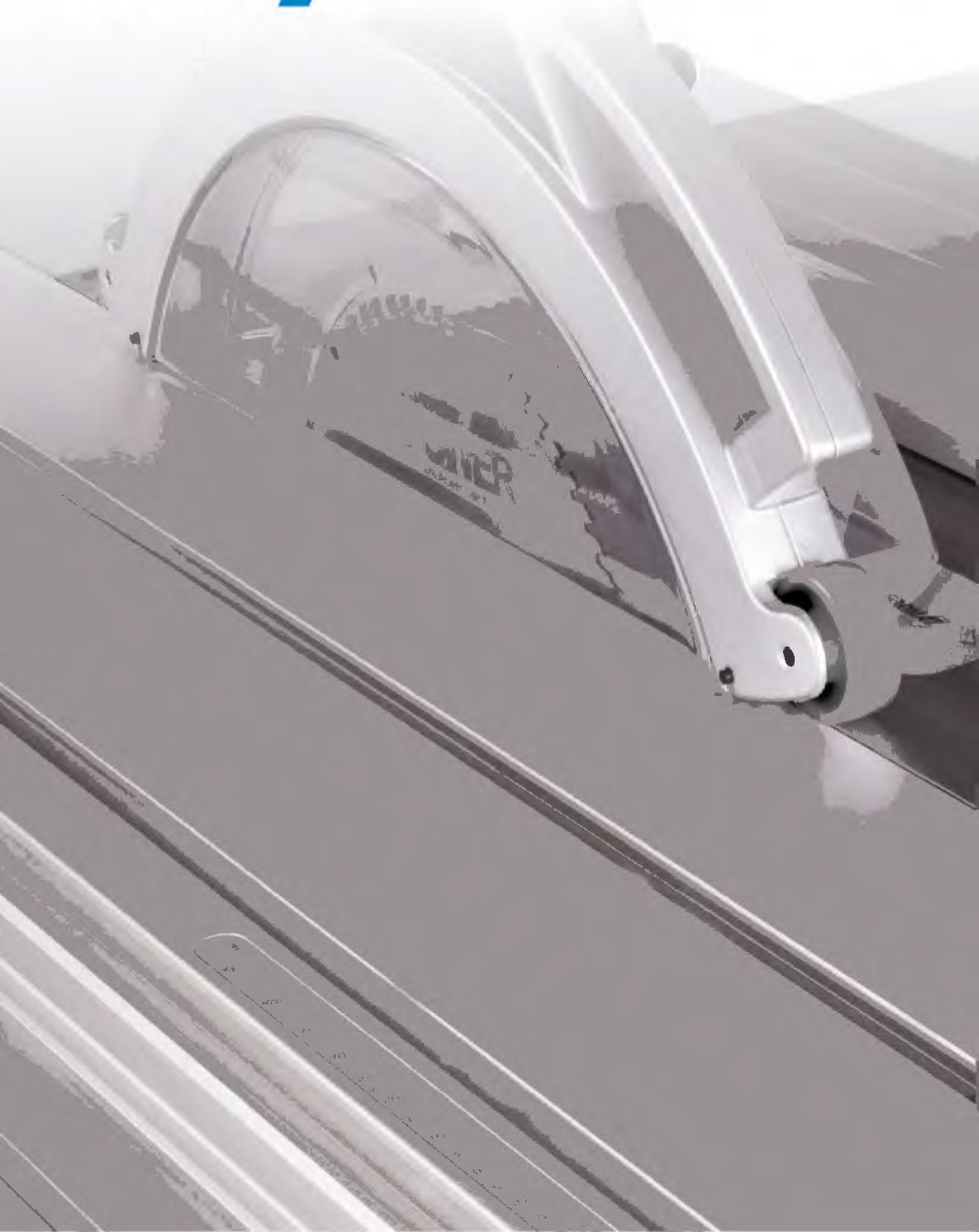

kappa 550

The first choice for panel saws



kappa 550

FORMAT.

Setting the standard
for size, performance
and precision

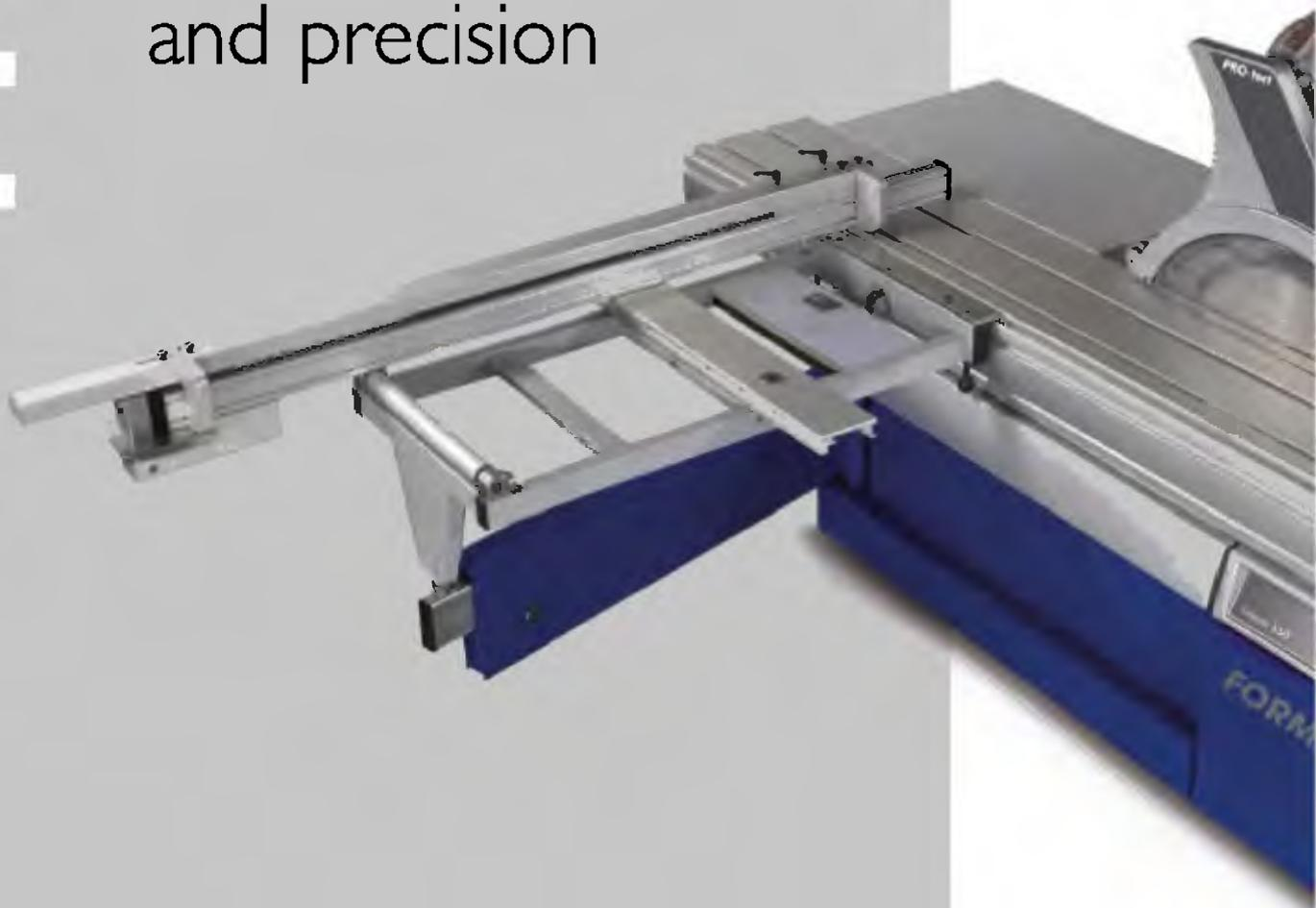

The first choice for panel saws:
The particular highlights of the kappa 550
e-motion are the automatic rip fence, unlimited
tooling data storage positions and programmable
cutting sequences. On the clearly laid out
TFT touch-screen operating panel you
can intuitively carry out all the working
steps from a central position.



"digi-compensation plus"

Tool free saw blade change system

"X-Roll" outrigger table

The new "X-Roll" sliding table

Parking the outrigger

Scoring unit with park position



kappa 550 x-motion



kappa 550

Precision circular saw unit, 202 mm cutting height

Sensational: Scoring unit with park position

- The scoring blade no longer needs to be removed!
- The scoring blade can be parked at the push of a button
- Saw blades with a diameter of up to 550 mm can be inserted without having to remove the scoring blade

NEW: 3-axis "Control" scoring unit - Save and retrieve scoring positions

- Electronic control for setting the saw blade height, angle and the rip capacity
- Save and retrieve scoring blade positions
- Saw blade diameter not limited as scoring blade can be moved into the park position

Large cutting depth, even with a scoring unit

- 202 mm cutting height at 90°,
141 mm at 45°
(saw blade Ø 550 mm)
- 27 mm cutting height with scoring
unit (saw blade Ø 400 mm)
- Saw blades with a max Ø 400 mm
can be lowered under the table

Saw shaft in cast iron housing, double bearing precision

- Absolute vibration-free machining
- Incredible power transmission due to the ultra
efficient POLY-V-belt drive technology

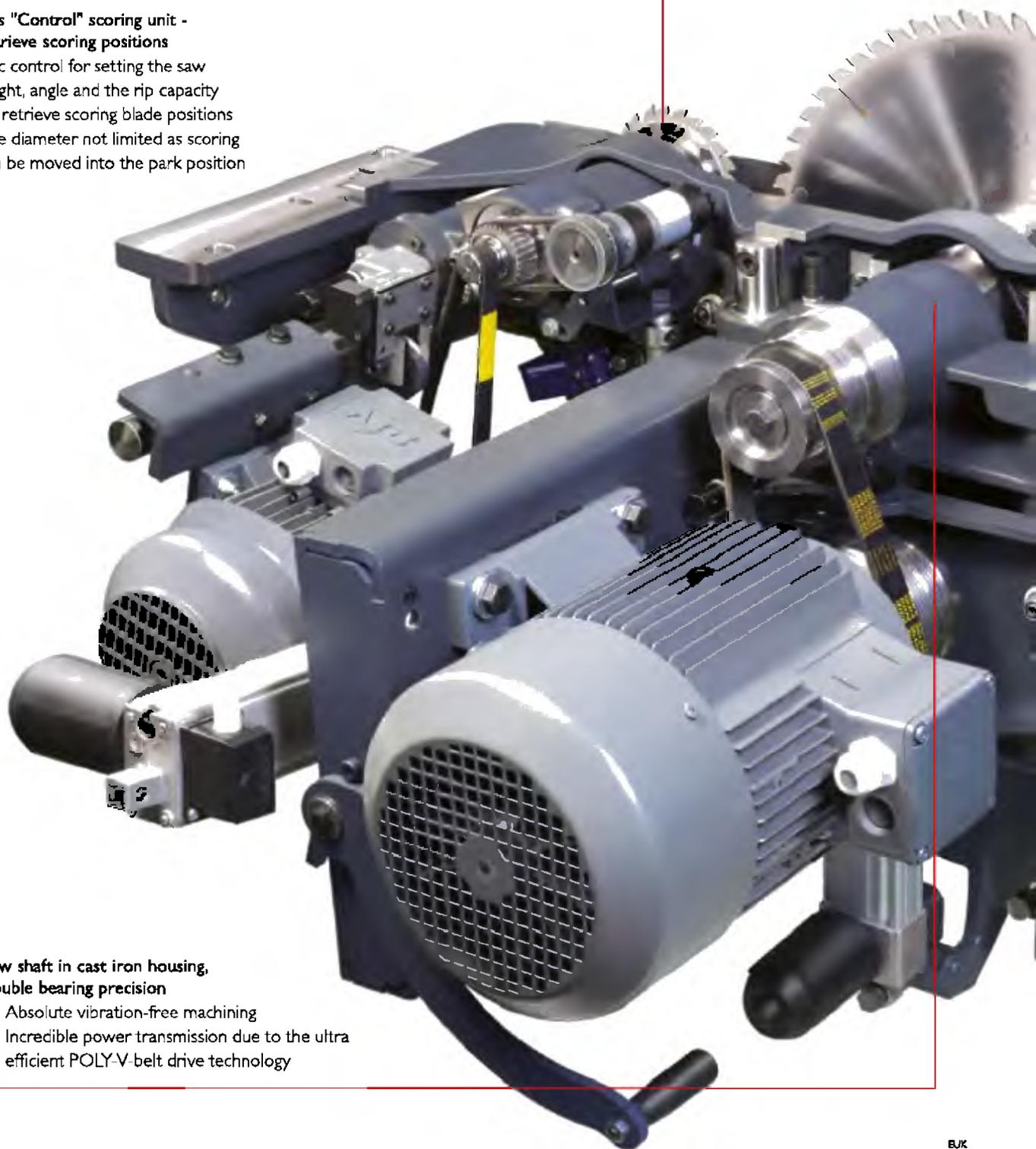

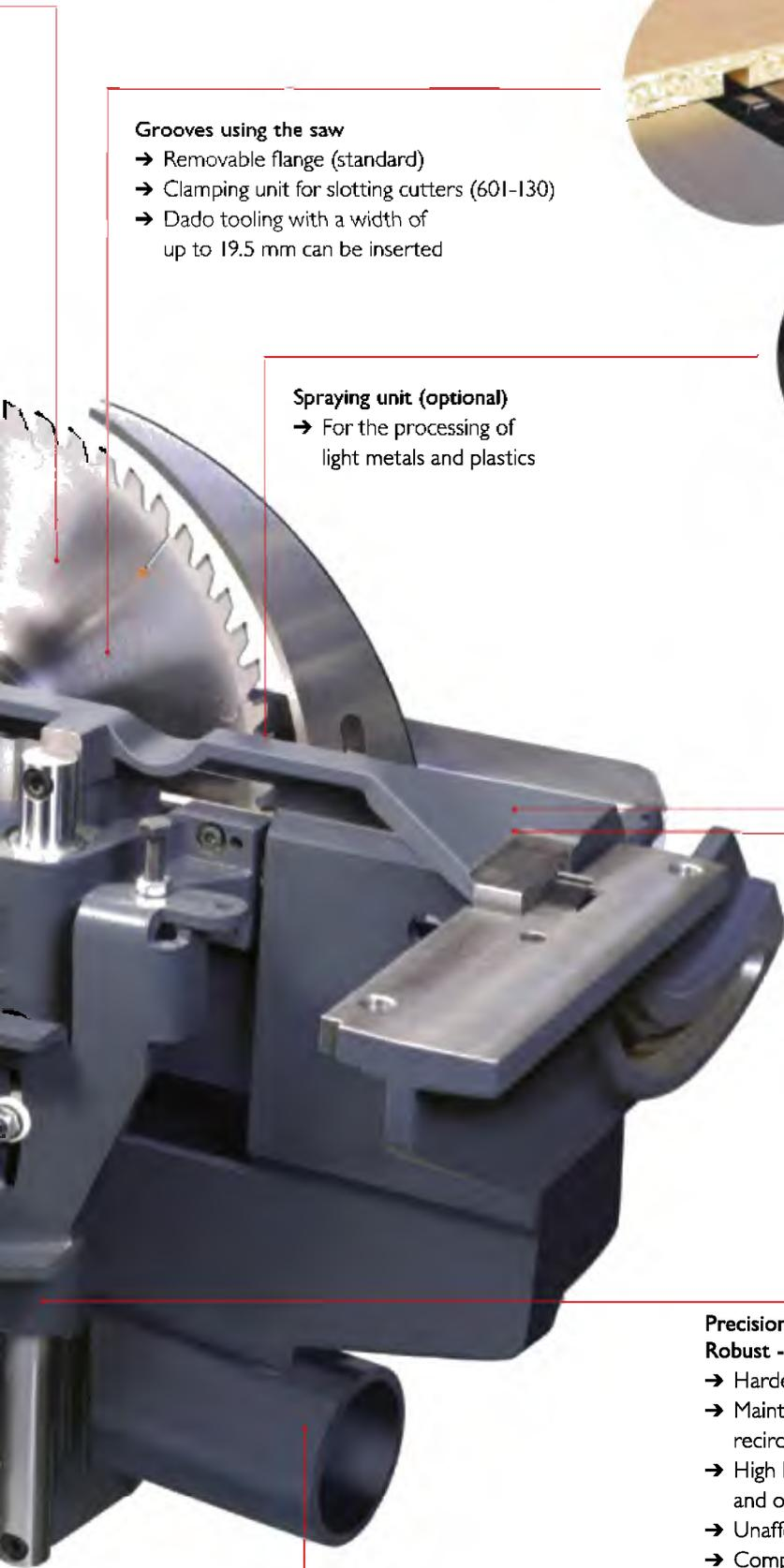

Grooves using the saw

- Removable flange (standard)
- Clamping unit for slotting cutters (601-130)
- Dado tooling with a width of up to 19.5 mm can be inserted

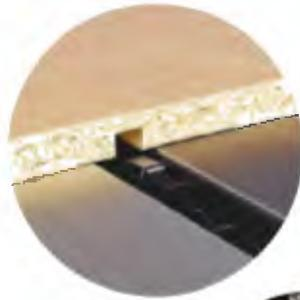

Spraying unit (optional)

- For the processing of light metals and plastics

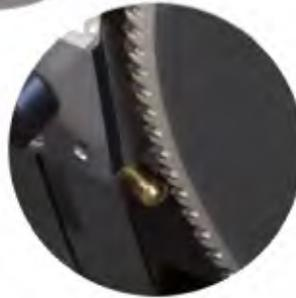

Saw blade tilt

- Saw blade tilt 0–46°
- 202 mm cutting height 90°, 141 mm cutting height at 45°

The “Easy-Glide” tilt segment, unrivalled!

- Precise, double sided guide support
- High load-bearing capacity and operating life
- Play-free tilt
- Unaffected by dust
- Completely maintenance free
- No lubrication required
- 6 Year Guarantee



**Precision height adjustment
Robust - Precise - Durable**

- Hardened precision linear guides
- Maintenance-free recirculating ball bushings
- High load-bearing capacity and operating life
- Unaffected by dust
- Completely maintenance free
- No lubrication required

Dust extraction below the table for great extraction results

- Extremely well designed dust extraction pipe for optimum results
- Optimised flow of dust from the scoring unit





Scoring unit

"Control" scoring unit

The scoring unit blade width and height adapt automatically to the stored tool information and also to the respective teeth width of the main saw blade. Any changes to these standard scoring settings can be saved and retrieved when using the same tool in the future. The 3-axis scoring unit "Control" is available as an option with the x-motion and e-motion models.

Scoring unit with 2 controlled axes

The scoring unit blade height and lateral position relating to the saw blade can be positioned with ease using the control panel. The scoring blade data can be saved in the database specific to a certain saw blade. Next time the saw blade is used, the scoring blades moves automatically into position.

"Classic" scoring unit

The height and lateral scoring blade settings can be manually adjusted from the top of the saw table. Optionally you can equip the "Classic" scoring unit with the electrically controlled "Automatic" height positioning option:

"Automatic" height adjustment

The scoring blade height setting is electrically adjusted with the turn of a knob, whereas the lateral settings are adjusted manually. Once the scoring blade is switched on, it moves automatically to its previously set vertical position and moves back completely under the saw table when switched off. Top of the range comfort!

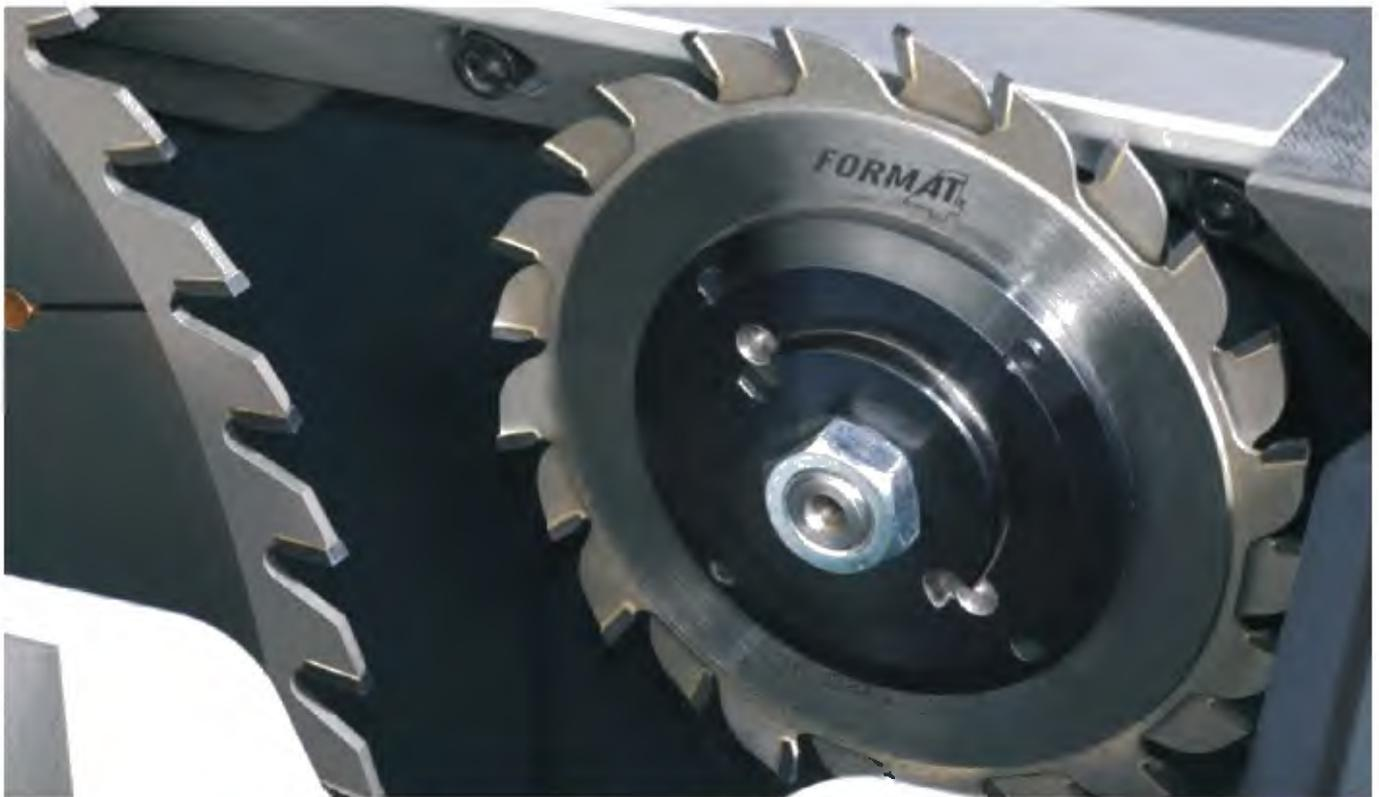

The scoring unit no longer needs to be removed

The scoring blade no longer needs to be removed when using a larger saw blade. The new Format-4 parks the scoring blade at the touch of a button, leaving enough space for a large diameter blade, and in doing so, saves valuable production time. Additionally the park position also protects the scoring blade from resin.



Saw blade change without tools

Fast, uncomplicated and totally without tools: Changing the saw blade on the new Format-4 machine is incredibly simple - simply incredible! The patented power transfer system creates the required pressure on the flange. A clamping lever is used for the tool free clamping of the riving knife. Maximum operating safety and maximum productivity are guaranteed with Format-4.





kappa 550 x-motion, up to 6 positionable axes

CNC control with 5.7" (145 mm) colour touch screen in the overhead control panel

- Positioning control of the saw blade height
- Positioning control of the saw blade angle
- Automatic cutting depth compensation when tilted
- Saw speed display
- Control for variable saw blade speed (option)
- Positioning control of the rip fence with automatic measurement correction when the saw blade is at an angle (option)
- All functions can also be adjusted in touch control mode
- 99 memory positions in the tooling database
- 9x 99 storage locations for cutting programs
- + Control of the 3-axes scoring unit "Control" (option)
- + Control of the 2 axes scoring unit (option)
- + Programs with stored functions (grooves, row of grooves, rabbets, wrong mitre, mitred cuts, calculator, length compensation of mitre cuts, double mitre cut)

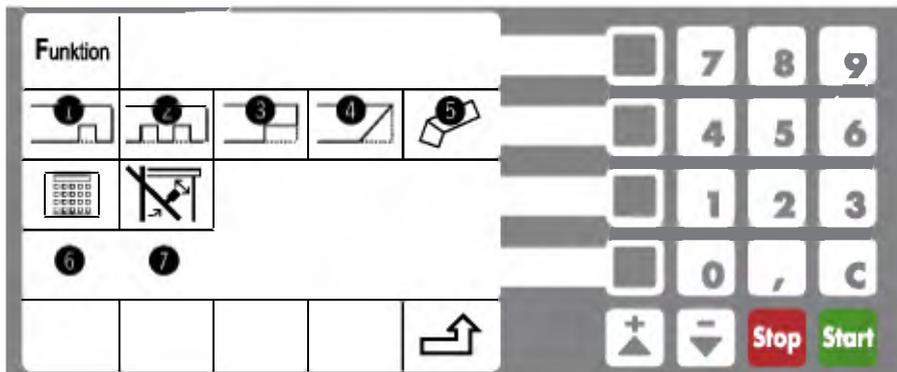

Special functions, x-motion standard

These special functions are always recalculated for the tool currently being used and converted into a program (cutting sequence).

- ① Grooves
- ② Row of grooves
- ③ Rabbets
- ④ Diagonal cuts
- ⑤ Wrong mitre
- ⑥ Calculator
- ⑦ Length compensation for mitred cuts and double mitre cuts

kappa 550 e-motion, up to 7 positionable axes

CNC control with 10.4" (264 mm) TFT touch screen in the overhead control panel

- Positioning control of the saw blade height
 - Positioning control of the saw blade angle
 - Automatic cutting depth compensation when tilted
 - Saw speed display
 - Control for variable saw blade speed (option)
 - Positioning control of the rip fence with automatic position correction when the saw blade is at an angle
 - All functions can also be adjusted in touch control mode
 - Unlimited tool storage positions
- + Unlimited number of cut program storage positions
 - + Control of the 3-axes scoring unit "Control" (option)
 - + Program with stored functions (grooves, row of grooves, rabbets, wrong mitre, mitred cuts, calculator)
 - + Programs with the possibility of free program designation
 - + USB-Port
 - + Preparation for network connection
 - + Ardis Cutting Optimisation Software (option)
 - + Barcode scanner, label printer (option)



Ardis Cutting Optimization Software



It is now even easier to optimise the cuts on your Format-4 panel saw. This has been made possible by the integration of the Ardis cutting optimisation software into the Format-4 operating concept. All of the functions are clearly displayed on the user interface. This makes it possible to check the tool width and the first cut quickly and easily, and with décor boards the direction of grain depicted in the material list - this saves you time, material and ultimately money.

The advantages are clear

All processing phases can be carried out quickly, efficiently and centrally as a result of the integration of the Format-4 cutting optimisation system into the machine and operating concept. Training is not necessary as the user friendly interface is intuitive, clear and easy to use.



Label printer

Not only does the label printer enable the workpieces to be labelled correctly, it also enables a rational post-processing. This makes it possible to load programs for subsequent processes on the CNC and edgebanders simply by using the bar code scanner. Save valuable production time with the label printer and increase productivity, quality and as a result, your profit.



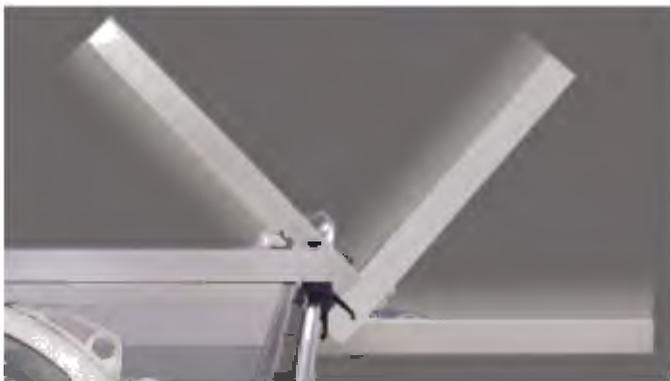

Top standard equipment

Clear scale on the machine table for the exact setting and also the swing away function of the rip fence.

→ Table scale as standard

→ Fine adjustment as standard



Rip fence

Rip cuts of the highest quality

The rip fence is easy and smooth to adjust, with a single-handed clamping mechanism. The optional fine adjustment makes precise measurements possible. A rip capacity of 1,000 mm is standard with the option of upgrading to a rip capacity of 1,250 mm or 1,600 mm. The rip scale is easy to read and perfectly integrated into the machine table. The aluminium rip fence can be pushed further back to improve user comfort and safety when making repeat offcuts.

Electronic digital display can be read from every position.

Perfectly integrated into the rip fence, the electrical digital display shows the rip setting accurate to a tenth of a millimetre. The display can be rotated through 90° depending on the working position. Additional functions such as the setting for incremental cuts also help to make day to day work easier.

Additional highlights such as the electronic digital display:

- Easy to read values, with a bright, red LED display
- No batteries required as it is connected to the power supply of the machine
- Automatic recognition, whether the fence is in the vertical position or laid flat
- Compensation for the tooth width of the saw blade



When working with narrow and thin cuts of wood with the saw blade at an angle, the aluminium fence can be placed face down to improve operator comfort and avoid collision with the saw blade.

Positioning control of the rip fence

The rip fence is positioned by a motor and runs via a dust-free integrated ball spindle in the saw table. The 1/10 mm precision, the high positioning speed, as well as the simultaneous positioning of the crosscut fence, saw blade height and saw blade angle ensure precision and save valuable working time.

- Automatic measurement correction when the rip fence is laid flat
- Rip fence park position
- No collision possible with the saw blade due to the coordination of the tool database by the positioning control
- The rip fence can be swung away at any point along the full rip capacity





10 year guarantee on the "X-Roll" sliding table

A masterpiece of engineering.
The ultimate in precision and smoothness!

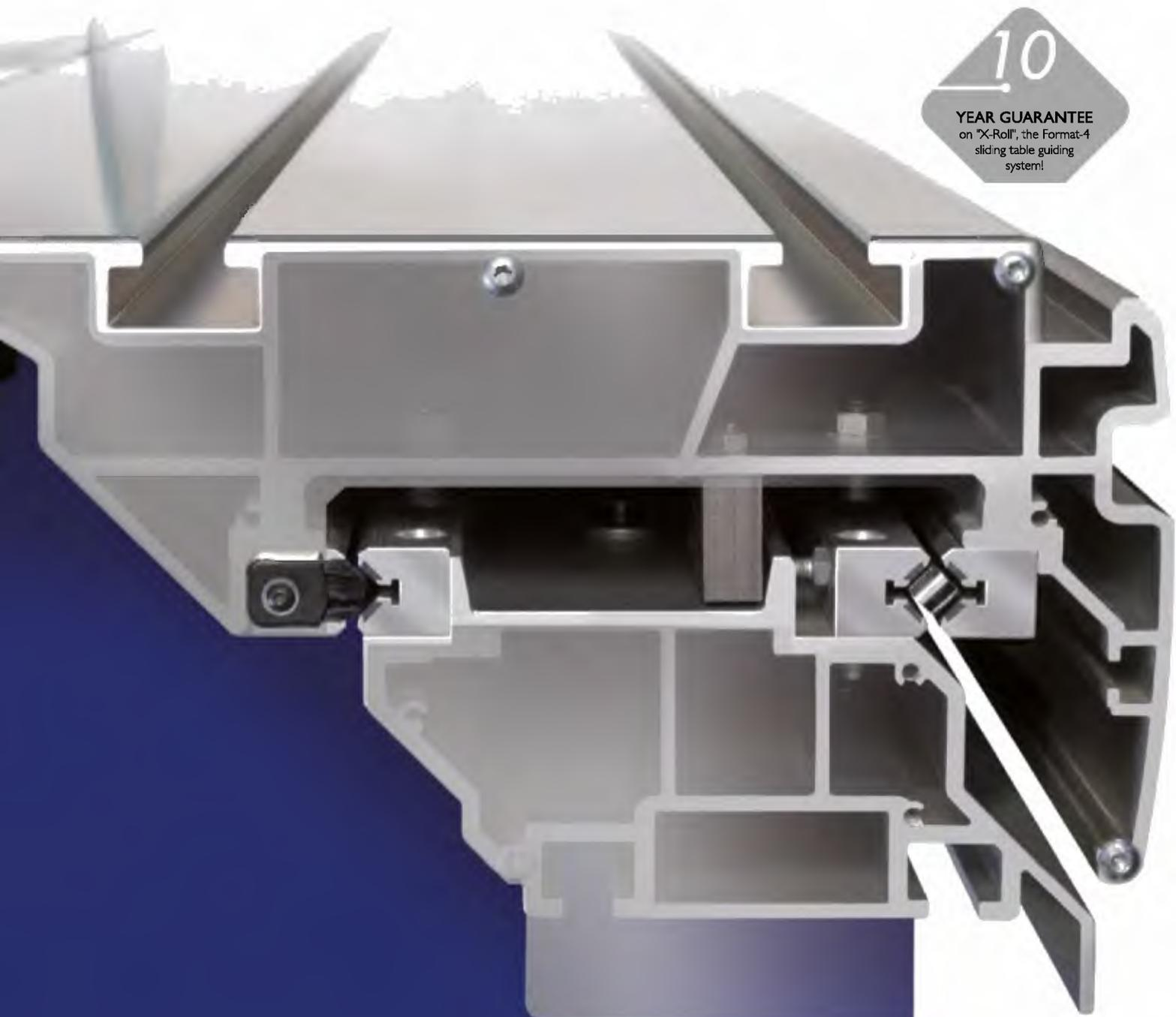

10
YEAR GUARANTEE
on "X-Roll", the Format-4
sliding table guiding
system!

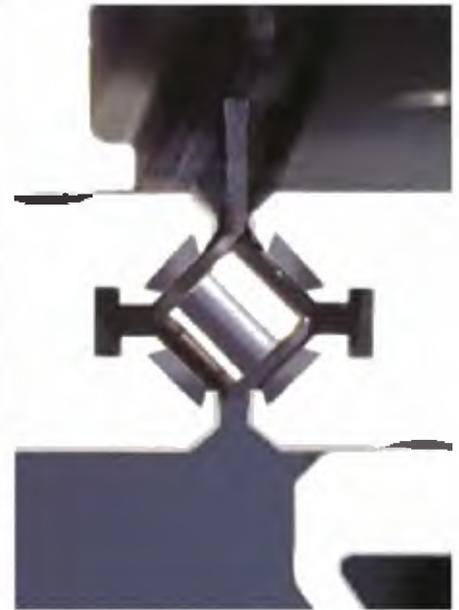
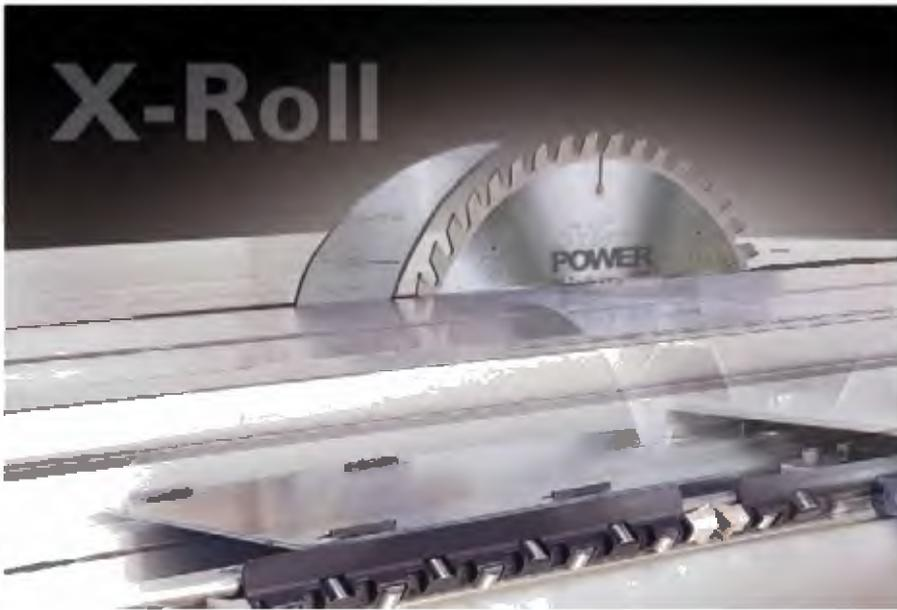

Large dimensioned and designed with high use in mind, the aluminium format sliding table "hovers" on the "X-Roll", a highly developed guiding technology for Format-4 sliding tables. The X shape ("X-Roll") design of the rollers distributes the load optimally on all sides.

The linear surface of the steel rollers running on the hardened and ground guiding surface guarantees unbeatable precision and smoothness. "X-Roll" will guarantee you the quality and precision that you expect from your new panel saw. Another reason to choose Format-4: 10 year factory guarantee to underline the reliability of "X-Roll".



The durability:
Durable guides with Format-4 - linear guidance system, no single point contact due to the roller bearings.

Maintenance-free:
Maintenance free and protected from dust due to the covered guides facing inwards.

Protected from contamination:

Dust protection due to the special "I2-fold" wiper system

- 4 wiping brushes
- 8 silicone wipers

The stability:
Completely torsion resistant due to the solid profile construction.

This is why:

- Extremely smooth, long life guiding system! The roller bearings have no single point of contact!
- Dust resistant construction of the guiding system, ensuring clean and dust free guides.
- Hardened and ground guide tracks.
- 10 Year guarantee on "X-Roll", the Format-4 sliding table guiding system!



As an option, it is also possible to equip the saw with remote push buttons which control the "ON" switch of the main blade and scoring blade and are mounted to the sliding table, speeding up the work process further.

Outrigger table, the choice is yours ...



"X-Roll" outrigger table

Which has an "X-Roll" moveable support rail which is quick to position and is fine adjustable. It is possible to set the angle to an accuracy of 1/100° using the digital display. The crosscut fence can be mounted onto the outrigger in either the front or rear position. The angle/length compensation is carried out using either a nonius scale or "digi-compensation-plus". The "X-Roll" outrigger table combines the advantages of the standard outrigger and the parallelogram outrigger at an incredibly attractive price.

- Precise 90° stop
- Simple setting of the mitre angle
- Large supporting surface
- Maximum stability as a result of the welded frame construction

NEW: "digi-compensation plus"

The digital angle and length compensation module "digi-compensation plus" for X-roll or parallelogram outriggers compensate any changes in the length difference of the crosscut fence settings, as the angle is changed. The direct communication with the controls, also enables it to compensate the fence position of the crosscut stop to the width of the tooth and the tilt of the saw blade. This ensures that you always get an exact measurement without any recalibration when using different saw blades.



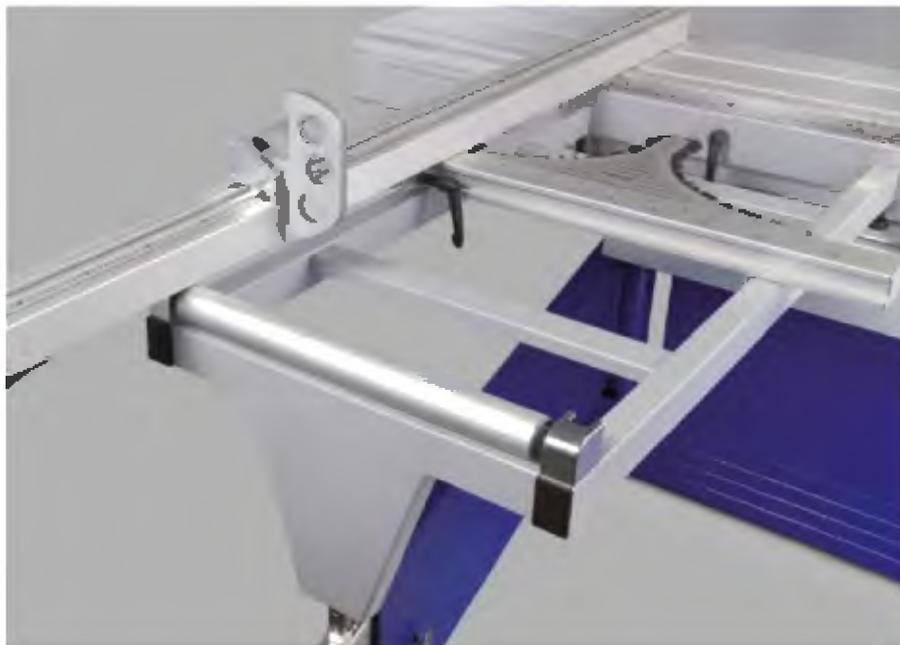

Precision mitre guide index system outrigger table

A time consuming cautious approach at setting the angle, as well reading and calculation errors are a thing of the past. Adjusting and locking without losing any time - the highly precise index points enable the exact production of polygons. Additional locking points in increments of five degrees between 15° and 45° can be used from the both the front and rear position. Each locking point is provided with length compensation and can be individually finely adjusted.

Parallelogram outrigger table

The solidly built parallelogram outrigger table enables mitre cuts from -45° to +45°. The workpieces support surface remains the same, regardless of the angle setting. It is possible to set the angle to an accuracy of 1/100° using the digital display. The angle/length compensation is carried out using either a nonius scale or "digi-compensation-plus".

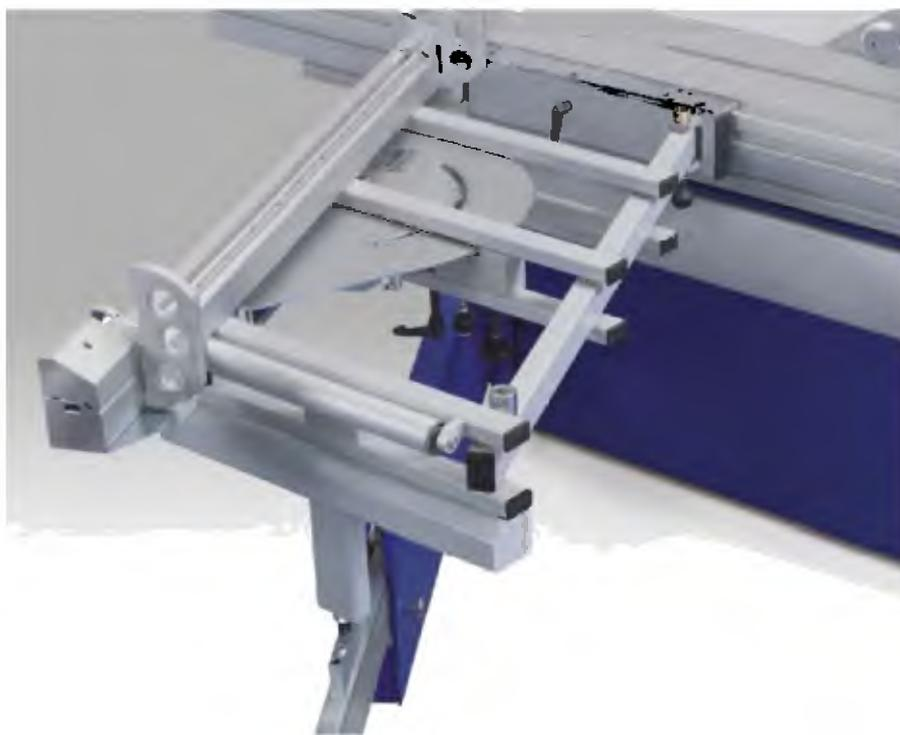



Digital and accurate to a tenth of a millimetre

As an option we can equip your Format-4 with a digital outrigger crosscut fence. The stylish integrated electronic digital display shows the adjustment accurate to a tenth of a millimetre. Additional functions such as the fine-adjustment and the setting for incremental cuts also help to make day to day work easier.

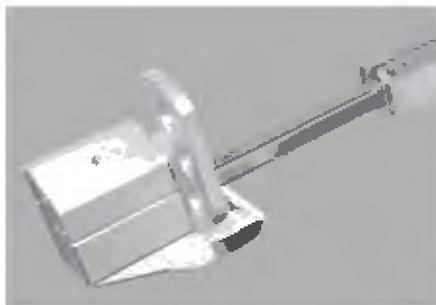

Outrigger crosscut fence

The outrigger crosscut fence makes it possible to carry out crosscuts up to 3,200 mm. Already in the standard equipment, technology and comfort of the highest order. The scale that is tilted towards the operator and the lens on the crosscut fence guarantee precise settings.



Parking the outrigger

The outrigger no longer requires dismantling, very easy to operate and small space requirement. The outrigger table can be swung out of the way with ease! No more complicated mounting and removing of the outrigger table. The tilting unit of the new kappa 550 ensures operating comfort that is of the extra class and also saves valuable workshop space.

Available as an option for the:

- Standard outrigger table
- Outrigger table with precision mitre guide index system
- "X-Roll" outrigger table
- Parallelogram outrigger table



Electronic crosscut fence

The e-motion models can be equipped with the CNC controlled crosscut fence. The controlled crosscut fence can be used on both sides of the outrigger and is equipped with two fence stops. The maximum adjustable length measures 3,400 mm. The extendable component can be removed to save space. The length compensation takes place automatically depending on the angle set.

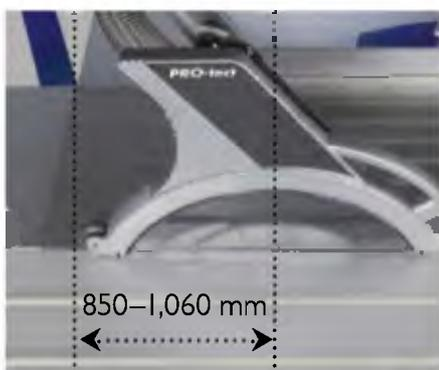

Overhead saw guard

The Format-4 overhead saw guard is elegantly integrated into the machine design. The operation is simple and comfortable. With a turn of a knob, the overhead saw guard can be unlocked and swung completely out of the machine table area. The extraction hood adjusts itself automatically to the workpiece height and offers optimum working safety and extraction performance.

The free cut from the centre of the saw blade to the overhead support is 850 mm with a maximum cutting height. Depending on the cutting height and the saw blade diameter, a free cut of up to 1,060 mm can be achieved. This makes it possible to be able to cut longer panels such as kitchen worktops.

The newly developed overhead saw guard and under table extraction system deliver perfect extraction results. The overhead saw guard, runs on linear guides that help to facilitate the height adjustment. The dust and shavings are sucked from the saw guard into the extraction pipe via a short hose.



Remote lock release

If desired, the kappa 550 can be equipped with a remote lock release. This enables you to easily swing the overhead saw guard away from the front of the machine.



Clamping systems

Pneumatic pressure bar

Both halves of the pressure segments can be controlled individually.
The clamping length is 3,000 mm and height is 80 mm.

→ Particularly suitable for long and thin materials such as veneer.



Pneumatic workpiece holder

Easy clamping of workpieces with maximum flexibility.
Can be used on all panel saws and spindle moulders that are equipped with a sliding table.

Advantages:

- Easy set up due to magnetic fittings
- Safety cylinder ensures maximum working security
- Pressure bar function is possible with every sliding table length
- Clamping height: 95 mm, clamping force approx. 300 kg

Details that impress!



Tooling compartment

- Integrated tooling storage in the machine chassis
- Storage room for 5 saw blades, max. Ø 400 mm



Spraying equipment

Your Format-4 can be optionally fitted with a spraying unit for the processing of non-ferrous metals or plastics. High performance lubricating oil can be sprayed directly onto the saw blade, transported via piping from the spraying unit.



Adjustment tool storage

Adjustment tool storage to the left of the saw blade integrated into the chassis - close to hand for comfortable working.

Technical specifications



		kappa 550	kappa 550 x-motion	kappa 550 e-motion
Cutting height		202 mm	202 mm	202 mm
Saw blade tilt		0°–46°	0°–46°	0°–46°
Rip capacity		1,000/1,250/1,600 mm	1,000/1,250/1,600 mm	1,000/1,250/1,600 mm
7.5 PS (5.5 kW)		S	S	S
10.0 PS (7.5 kW)		○	○	○
15.0 PS (11.0 kW)		○	○	○
Working height		890 mm	890 mm	890 mm
Length [L]	2,800 mm*	6,500 mm	6,500 mm	6,500 mm
	3,200 mm*	7,300 mm	7,300 mm	7,300 mm
	3,700 mm*	8,300 mm	8,300 mm	8,300 mm
Width [W ₁]		1,348/1,954/2,022 mm	1,348/1,954/2,022 mm	1,348/1,954/2,022 mm
Width [W ₂]		2,037/3,346 mm	2,037/3,346 mm	2,037/3,346/3,721 mm
Weight (depending on equipment, without packaging)		1,300 kg	1,300 kg	1,300 kg
Extraction connection-Ø saw aggregate/saw guard (overhead)		120/100 mm	120/100 mm	120/100 mm

*Cutting length with outrigger table and at maximum cutting height. **Details of the maximum travelling distance based on the length of the sliding table: S ... Standard configuration ○ ... Option - ... not available



Further information about the technical data, individual configuration options and all noise level values can be found on the internet at www.format-4.com

Space requirement

Scale
1:50

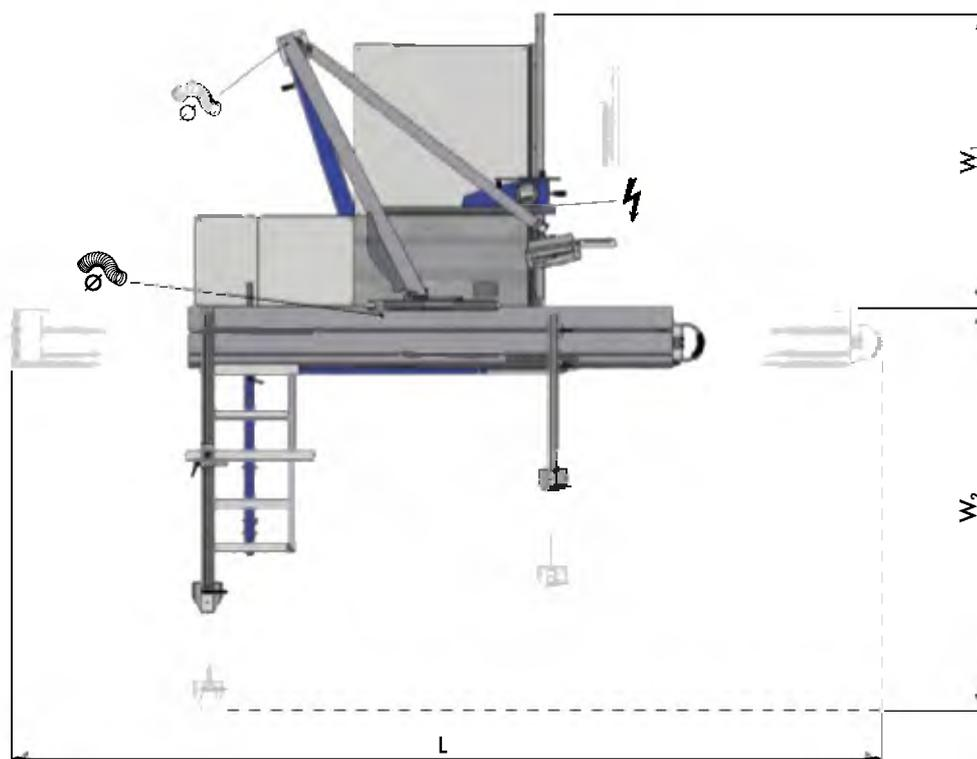

Symbolic image kappa 550, kappa 550 x-motion, kappa 550 e-motion

Dimensions given can vary if special options are selected

kappa 400

For the highest requirements



Kappa 400

FORMAT

Convincing in all areas

The Format-4 kappa 400 x-motion convinces in all areas. Other than the great price/performance ratio, the panel saw also impresses with the 3 axes control, heavy saw aggregate, format sliding table, operating comfort and precision.



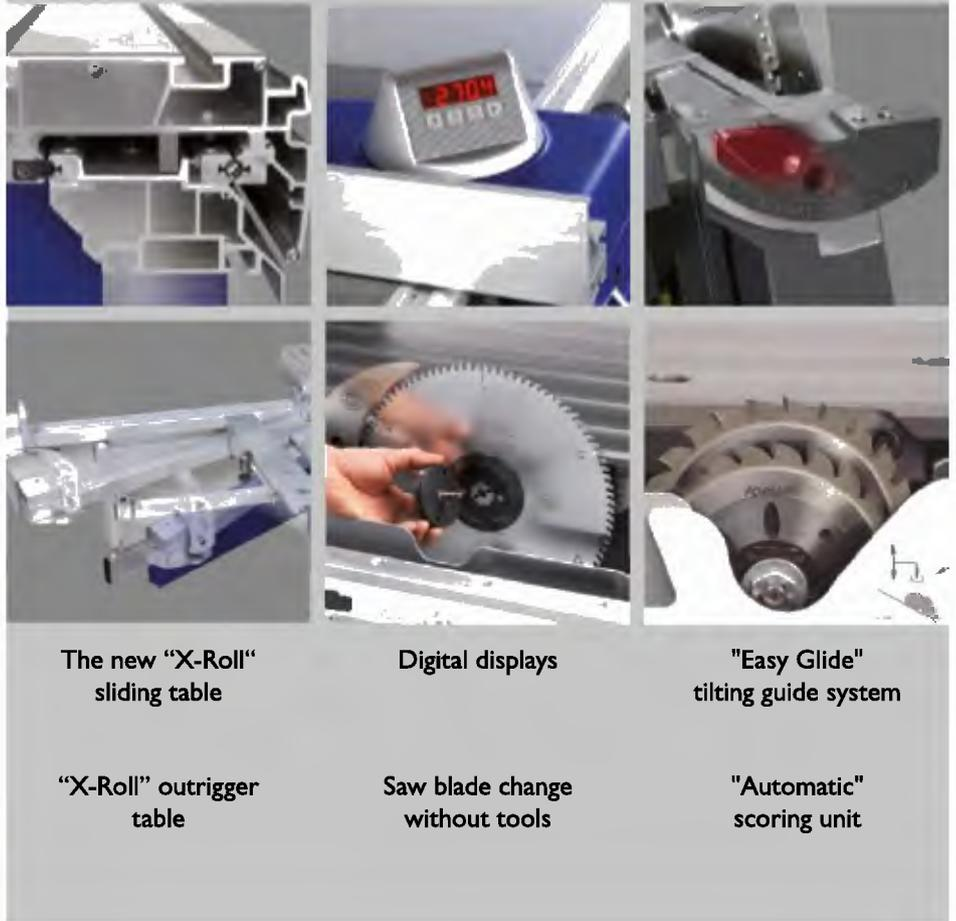

The new "X-Roll"
sliding table

Digital displays

"Easy Glide"
tilting guide system

"X-Roll" outrigger
table

Saw blade change
without tools

"Automatic"
scoring unit



kappa 400

Precision circular saw unit, 133 mm cutting height

The newly developed Format-4 saw unit made from cast iron offers not only high performance and precision but also extreme smoothness and efficiency:

- 133 mm cutting height with a 400 mm saw blade diameter
- Electronic height adjustment with digital LED display
- Electronic angle adjustment with digital LED display
- Saw blade tilt 90°–45°
- Large scale, double ball bearing saw arbour
- Maximum power transmission achieved through the large surface of the Poly-V belts
- 3 speeds: 3500/4500/5500 rpm
- Optimal extraction with a completely enclosed saw aggregate
- Dovetail guidance system of the height adjustment
- Precise, double sided guide support
- **6 year guarantee** on "Easy-Glide", the Format-4 tilting segment guide!
 - Maximum load bearing capacity
 - Play-free tilt
 - Unaffected by dust
 - Completely maintenance free
 - Completely lubrication free
- Optional: Use of dado tooling up to 19.5 mm in width



Format-4 panel saws also make it possible to carry out slot cutting. The use of adjustable dado tools, specifically developed by Format-4, can be used thanks to the removable circular saw flange and the table insert.

The saw shaft is enclosed in a solid cast iron housing. With the double bearing mounts, vibration free results are guaranteed. Power transfer from motor to saw blade is optimised through the use of a POLY-V belt.

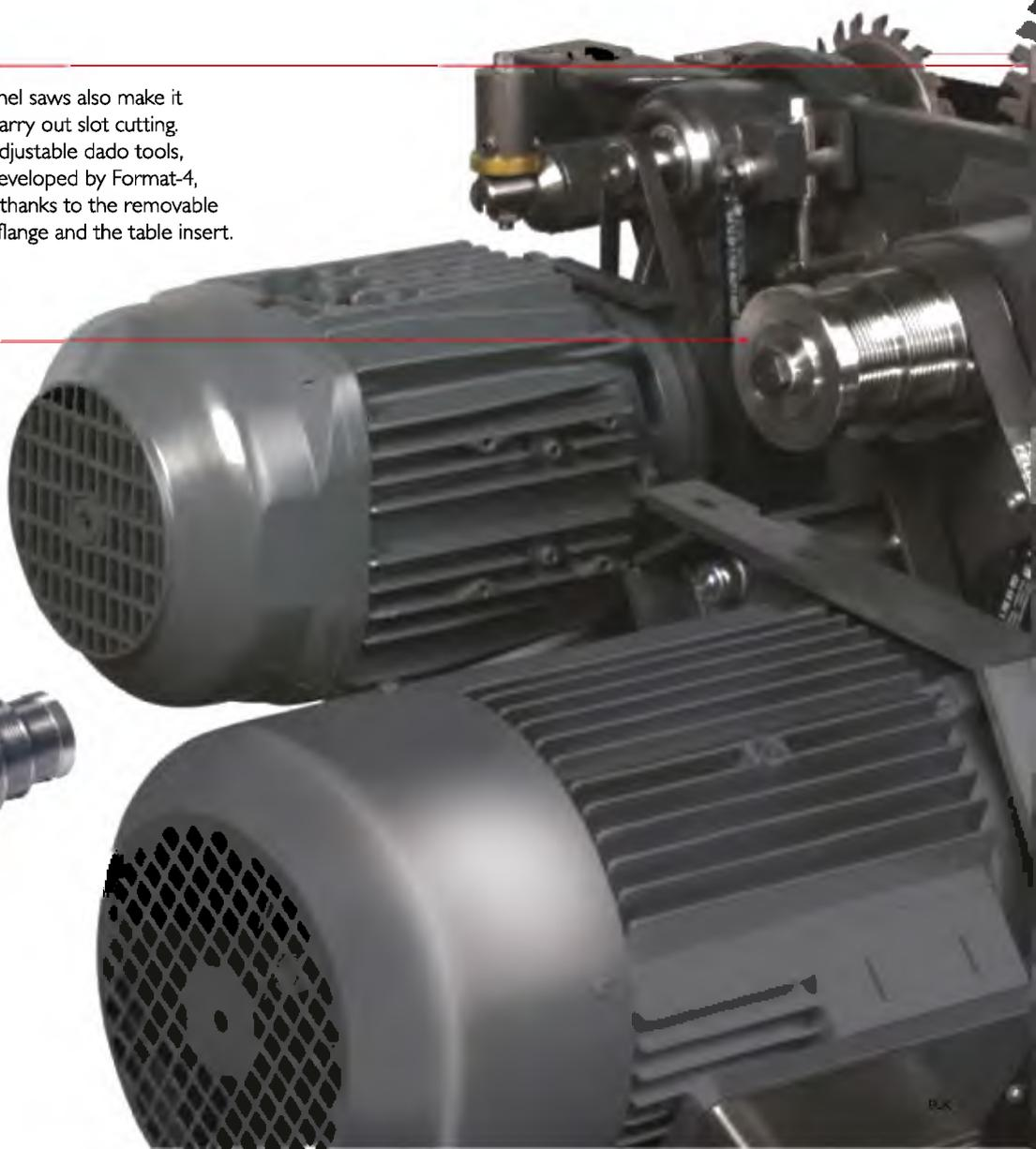

Scoring unit - you choose:

Classic: The height and lateral scoring blade settings can be manually adjusted from the top of the saw table.

Automatic: The scoring blade height setting is electrically adjusted with the turn of a knob, whereas the lateral settings are adjusted manually. Once the scoring blade is switched on, it moves automatically to its previously set vertical position and moves back completely under the saw table when switched off. Top of the range comfort!

NEW: Scoring unit with 2 controlled axes for the kappa 400 x-motion:

→ The scoring blade height and lateral position in relation to the saw blade can be easily set using the control panel.

→ The scoring blade data can be saved in the database specific to a certain saw blade. Next time the saw blade is used, the scoring blades moves automatically into position.



"Easy-Lock" tool free saw blade change

The clamping system is maintenance free and offers premium comfort for many years: Change saw blades effortlessly in literally no time at all.

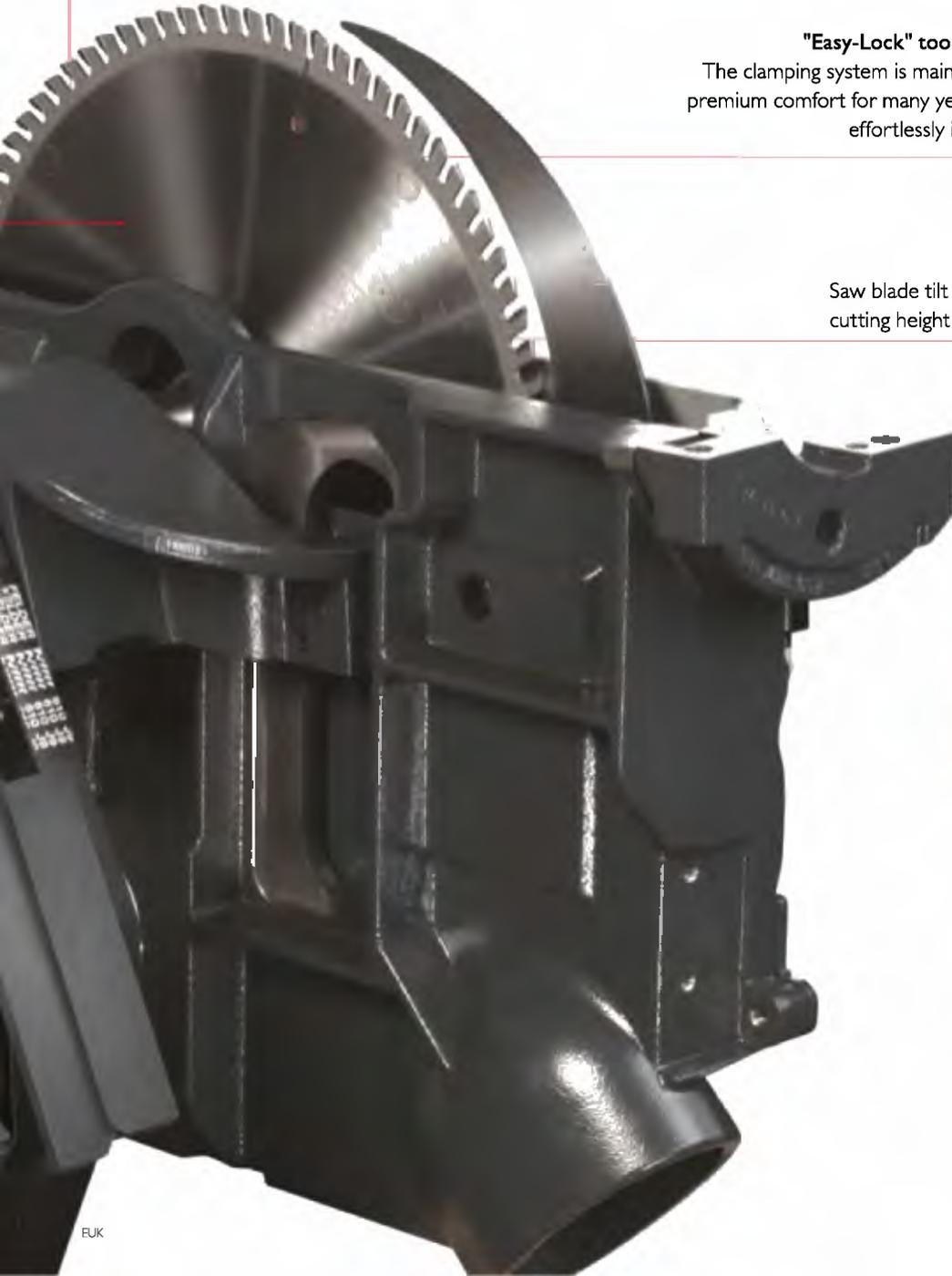

Saw blade tilt 90°-45°, cutting height 133 mm.





kappa 400, higher standard at the best price

Saw aggregate control "Power-Drive" Electric height and angle adjustment at the turn of a knob

With "Power-Drive" you are getting an electrically controlled saw blade height and angle adjustment system, that is top class. You can select the cutting height and cutting angle using a quick adjustment knob, fine adjustment is carried out using a push button. Red LED display screens in the control panel show exact adjustment values. Whilst tilting, the height setting will be compensated - the LED screen will always show you the actual cutting height. The clearly laid out operating field informs you of the current speed of the saw blade. The height of the scoring blade can also be electrically adjusted.

Up to 3 electrically controlled axes

- Saw blade height control
- Saw blade tilt control
- Scoring blade height adjustment (option)

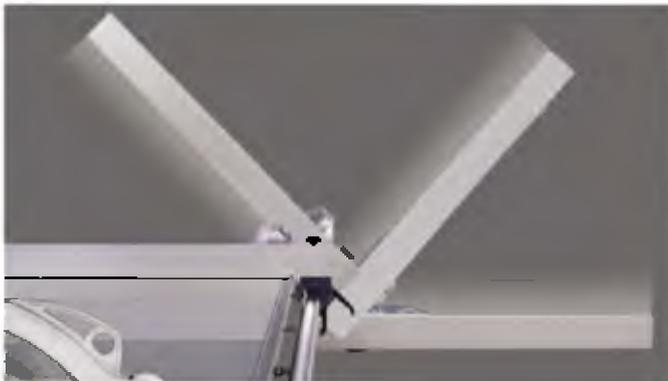

Top standard equipment

Clear scale on the machine table for the exact setting and also the swing away function of the rip fence.

- Table scale as standard
- Fine adjustment as standard



Rip fence

Rip cuts of the highest quality

The rip fence is easy and smooth to adjust, with a single-handed clamping mechanism. The optional fine adjustment makes precise measurements possible. A rip capacity of 800 mm is standard with the option of upgrading to a rip capacity of 1,250 mm. The rip scale is easy to read and perfectly integrated into the machine table. The aluminium rip fence can be pushed further back to improve user comfort and safety when making repeat offcuts.

Electronic digital display can be read from every position

Perfectly integrated into the rip fence, the electrical digital display shows the rip setting accurate to a tenth of a millimetre. The display can be rotated through 90° depending on the working position. Additional functions such as the setting for incremental cuts also help to make day to day work easier.

Additional highlights such as the electronic digital display:

- Easy to read values, with a bright, red LED display
- No batteries required as it is connected to the power supply of the machine
- Automatic recognition, whether the fence is in the vertical position or laid flat
- Compensation for the tooth width of the saw blade



When working with narrow and thin cuts of wood with the saw blade at an angle, the aluminium rip fence can be placed face down.



kappa 400 x-motion, up to 5 positionable axes

CNC-drive control unit with 5.7" LCD colour screen

(145 mm) positioned in the overhead control panel

- Automatic cutting depth compensation when tilting
- Saw speed display
- Control for variable saw blade speed (option)
- Positioning control of the rip fence with automatic measurement correction when the saw blade is at an angle (option)
- All functions can also be adjusted in touch control mode
- 99 memory positions in the tooling database

Up to 5 positionable axes

Setting new standards with the new kappa 400 x-motion

- Saw blade height control
- Saw blade tilt control
- Positioning control of the rip fence
- 9x99 cutting program, incremental measurement function
- 2 axes scoring unit as an option

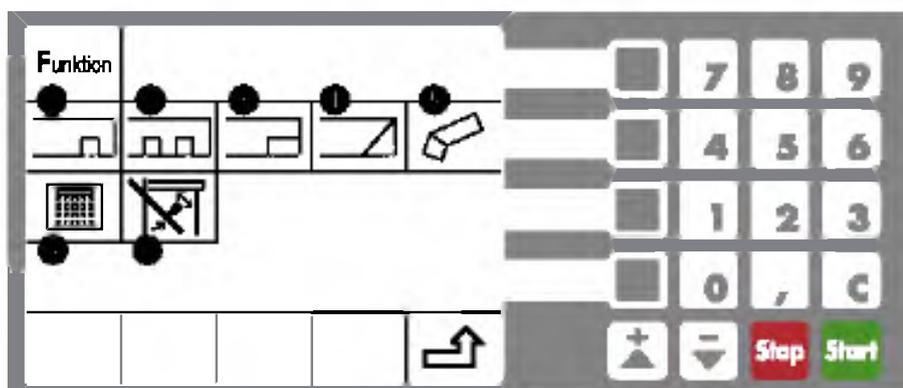

Special functions, x-motion standard

These special functions are always recalculated for the tool currently being used and converted into a program (cutting sequence).

- ① Grooves
- ② Row of grooves
- ③ Rabbits
- ④ Diagonal cuts
- ⑤ Wrong mitre
- ⑥ Calculator
- ⑦ Length compensation for mitred cuts and double mitre cuts

Positioning control of the rip fence

The rip fence is positioned by a motor and runs via a dust-free integrated ball spindle in the saw table. The 1/10 mm precision, the high positioning speed, as well as the simultaneous positioning of the crosscut fence, saw blade height and saw blade angle ensure precision and save valuable working time.

- Automatic measurement correction when the rip fence is laid flat
- Rip fence park position
- Keine No collision possible with the saw blade due to the coordination of the tool database with the positioning control
- The rip fence can be swung away at any point along the full rip capacity
- 800 mm or 1,250 mm rip capacity





"X-Roll" sliding table, 10 year guarantee

A masterpiece of engineering.
The ultimate in precision and smoothness!

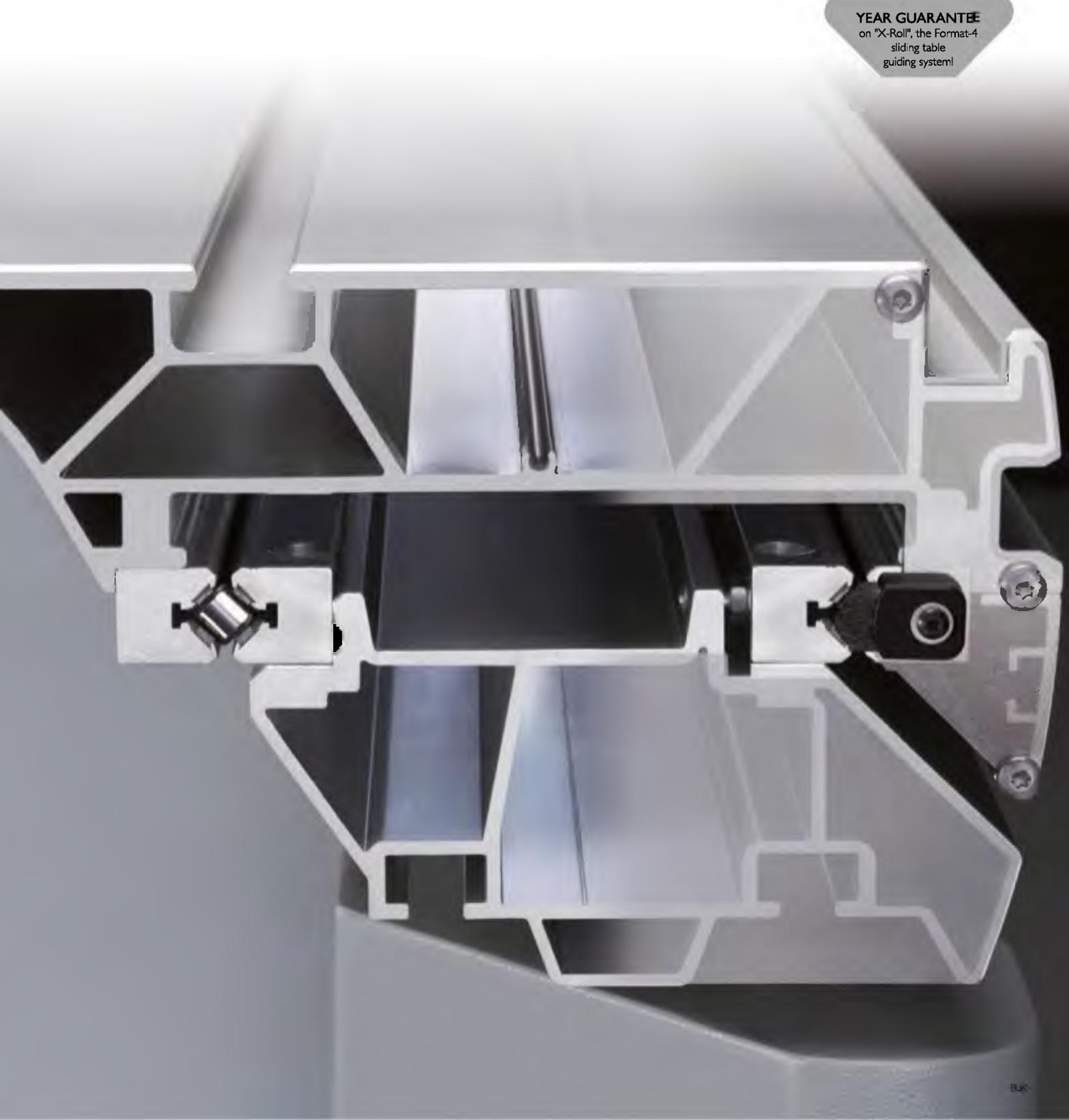

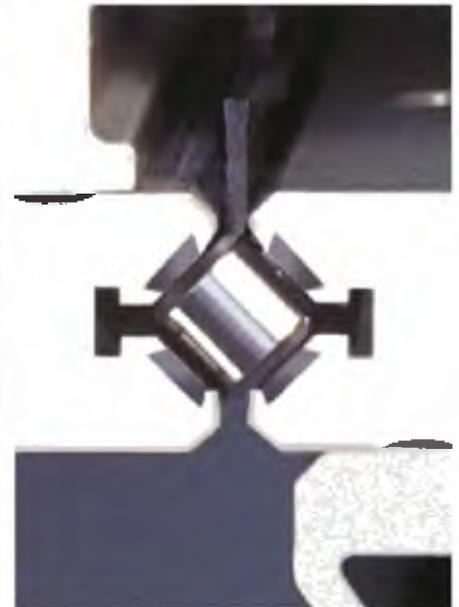
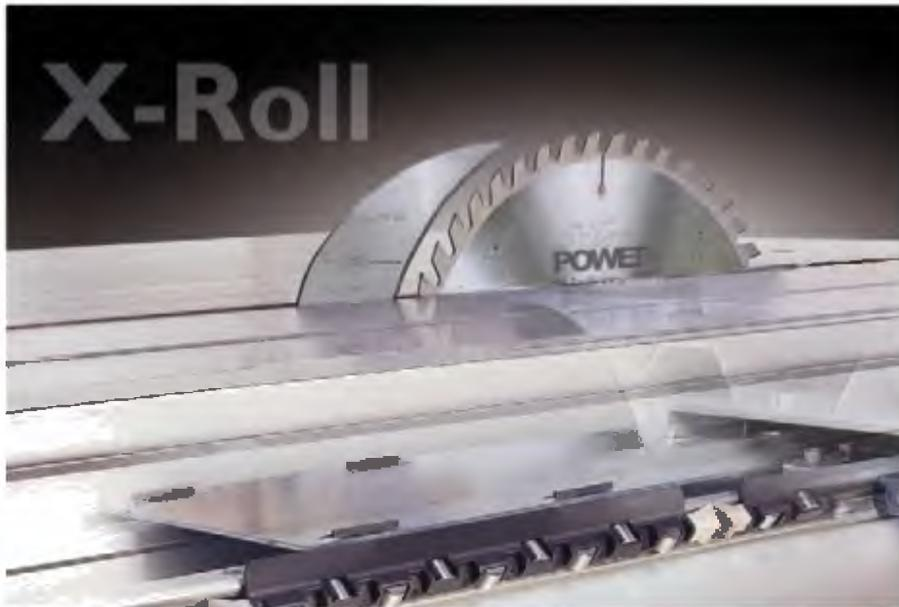

Large dimensioned and designed with high use in mind, the aluminium format sliding table "hovers" on the "X-Roll", a highly developed guiding technology for Format-4 sliding tables. The X shape ("X-Roll") design of the rollers distributes the load optimally on all sides. The linear surface of the steel rollers running on the hardened and ground guiding surface guarantees unbeatable precision and smoothness. "X-Roll" will guarantee you the quality and precision that you expect from your new panel saw. And another reason to choose Format-4: 10 year factory guarantee to underline the reliability of "X-Roll".



The durability:
Durable guides with Format-4 linear guidance system, no single point contact due to the roller bearings.

Maintenance-free:
Maintenance free and protected from dust due to the covered guides facing inwards and mounted to the side.

Protected from contamination:
Dust protection due to the special "12-fold" wiper system
→ 4 wiping brushes
→ 8 silicone wipers

The stability:
Completely torsion resistant due to the solid profile construction.

This is why:

- Extremely smooth, long life guiding system! The roller bearings have no single point of contact!
- Dust resistant construction of the guiding system, ensuring clean and dust free guides. Hardened and ground guide tracks.
- 10 Year guarantee on "X-Roll", the Format-4 sliding table guiding system!



As an option, it is also possible to equip the saw with remote push buttons which control the "ON" switch of the main blade and scoring blade and are mounted to the sliding table.

Outrigger table, the choice is yours ...

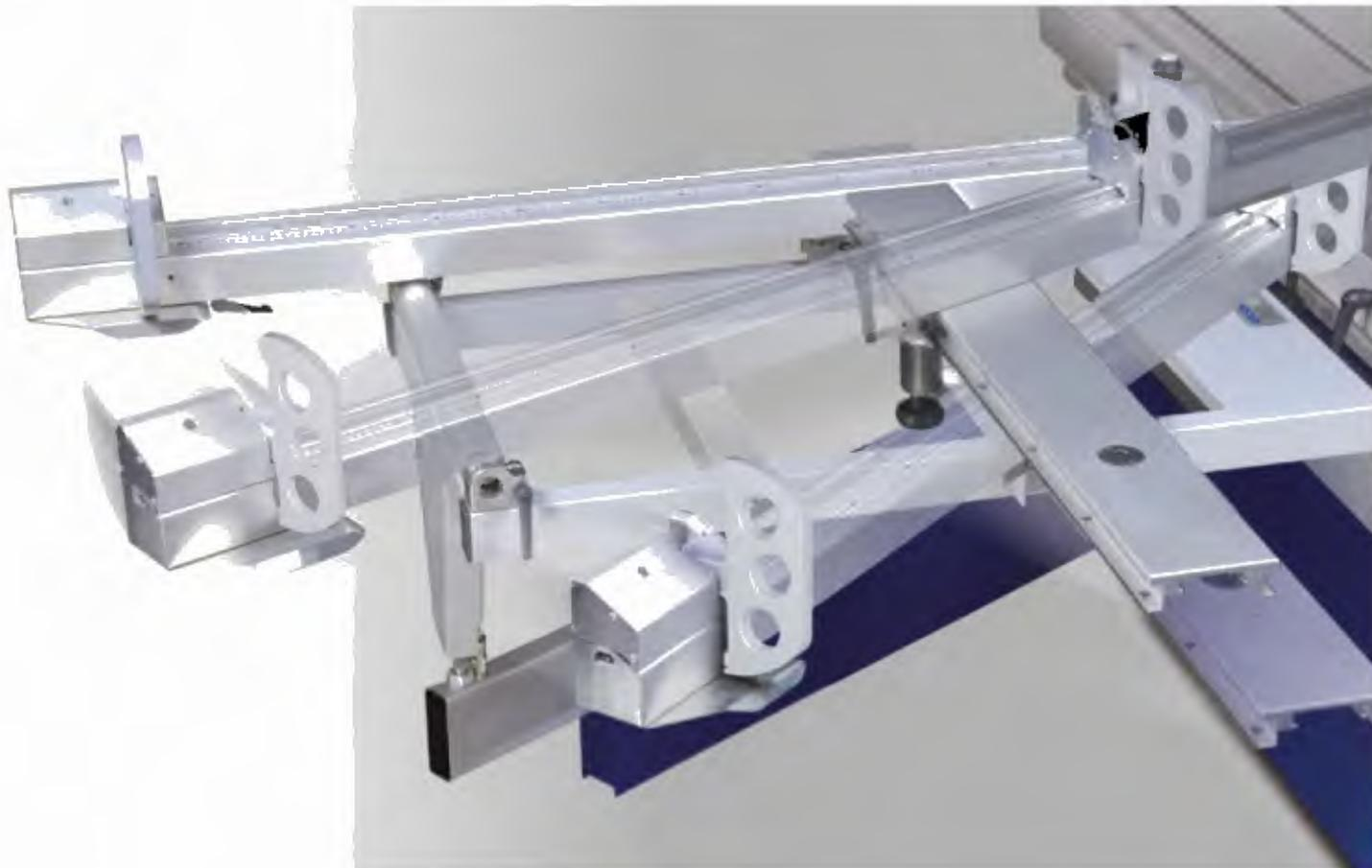

"X-Roll" outrigger table

has an "X-Roll" moveable support rail which is quick to position and is fine adjustable. It is possible to set the angle to an accuracy of 1/100° using the digital display. The crosscut fence can be mounted onto the outrigger in either the front or rear position.

The angle/length compensation is carried out using either a nonius scale or "digi-compensation-plus". The "X-Roll" outrigger table combines the advantages of the standard outrigger and the parallelogram outrigger at an incredibly attractive price:

- Precise 90° stop
- Simple setting of the mitre angle
- Large supporting surface
- Maximum stability as a result of the welded frame construction



NEW: "digi-compensation plus"

The digital angle and length compensation module "digi-compensation plus" for X-roll or parallelogram outriggers compensate any changes in the length difference of the crosscut fence settings, as the angle is changed. The direct communication with the controls, also enables it to compensate the fence position of the crosscut stop to the width of the tooth and the tilt of the saw blade. This ensures that you always get an exact measurement without any recalibration when using different saw blades.

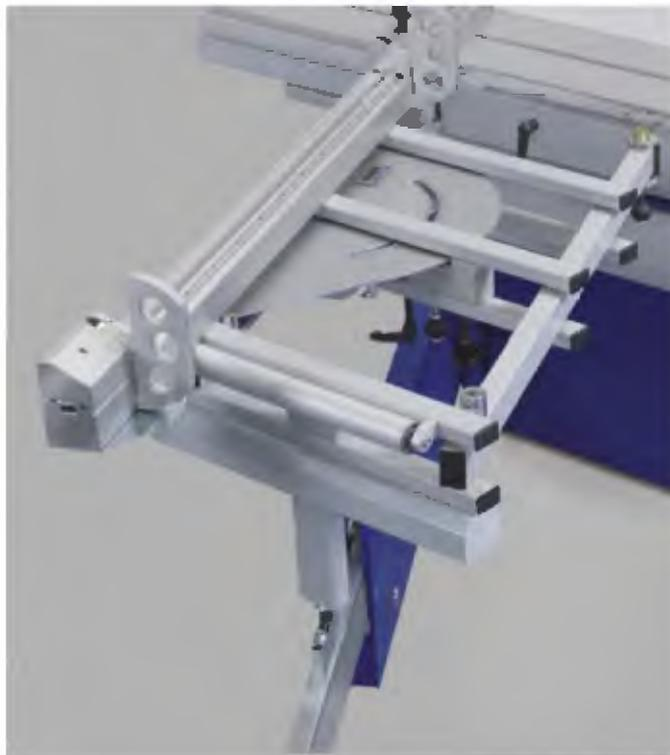

Parallelogram outrigger table

The solidly built parallelogram outrigger table enables mitre cuts from -45° to $+45^\circ$. The workpieces support surface remains the same, regardless of the angle setting. It is possible to set the angle to an accuracy of $1/100^\circ$ using the digital display. The angle/length compensation is carried out using either a nonius scale or "digi-compensation-plus".



Precision mitre guide index system outrigger table

A time consuming cautious approach at setting the angle, as well as reading and calculation errors are a thing of the past. Adjusting and locking without losing any time - the highly precise index points enable the exact production of polygons. Additional locking points in increments of five degrees between 15° and 45° can be used from both the front and rear position. Each locking point is provided with length compensation and can be individually finely adjusted.

Outrigger table

The outrigger table with workpiece roller is large in its design and the eight ball bearing guide rollers in the support arm ensure an extremely smooth movement, even when under maximum load.

90°-Guarantee

The outrigger crosscut fence can be positioned at 90° in just one movement. A bayonet connection on the outrigger table ensures repeatability of the right angle position.

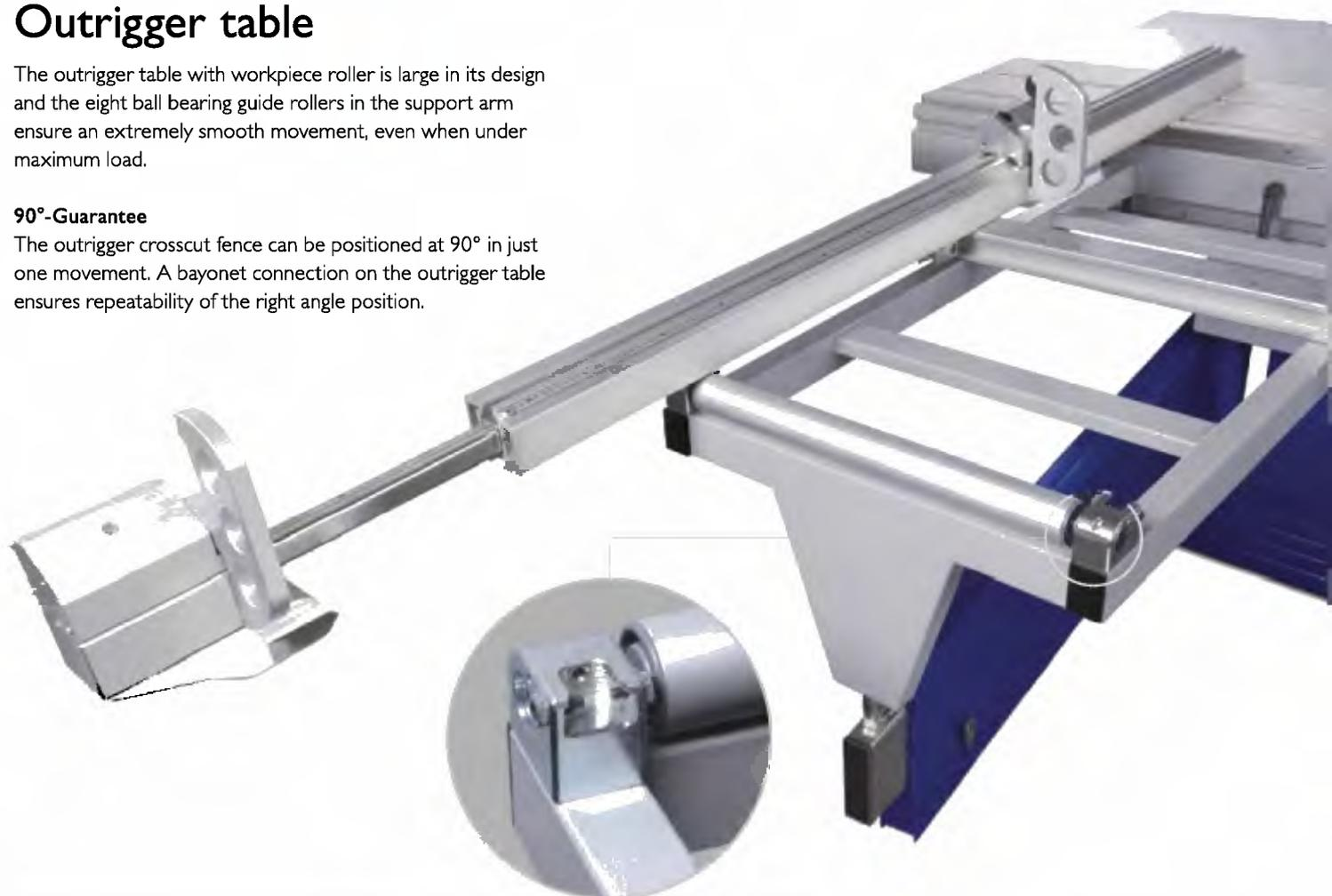

Digital and accurate to a tenth of a millimetre

As an option we can equip your Format-4 with a digital outrigger crosscut fence. The stylish integrated electronic digital display shows the adjustment accurate to a tenth of a millimetre. Additional functions such as the fine-adjustment and the setting for incremental cuts also help to make day to day work easier.

Outrigger crosscut fence

The outrigger crosscut fence makes it possible to carry out crosscuts up to 3,200 mm. Already in the standard equipment, technology and comfort of the highest class. The scale that is tilted towards the operator and the lens on the crosscut fence guarantee precise settings.

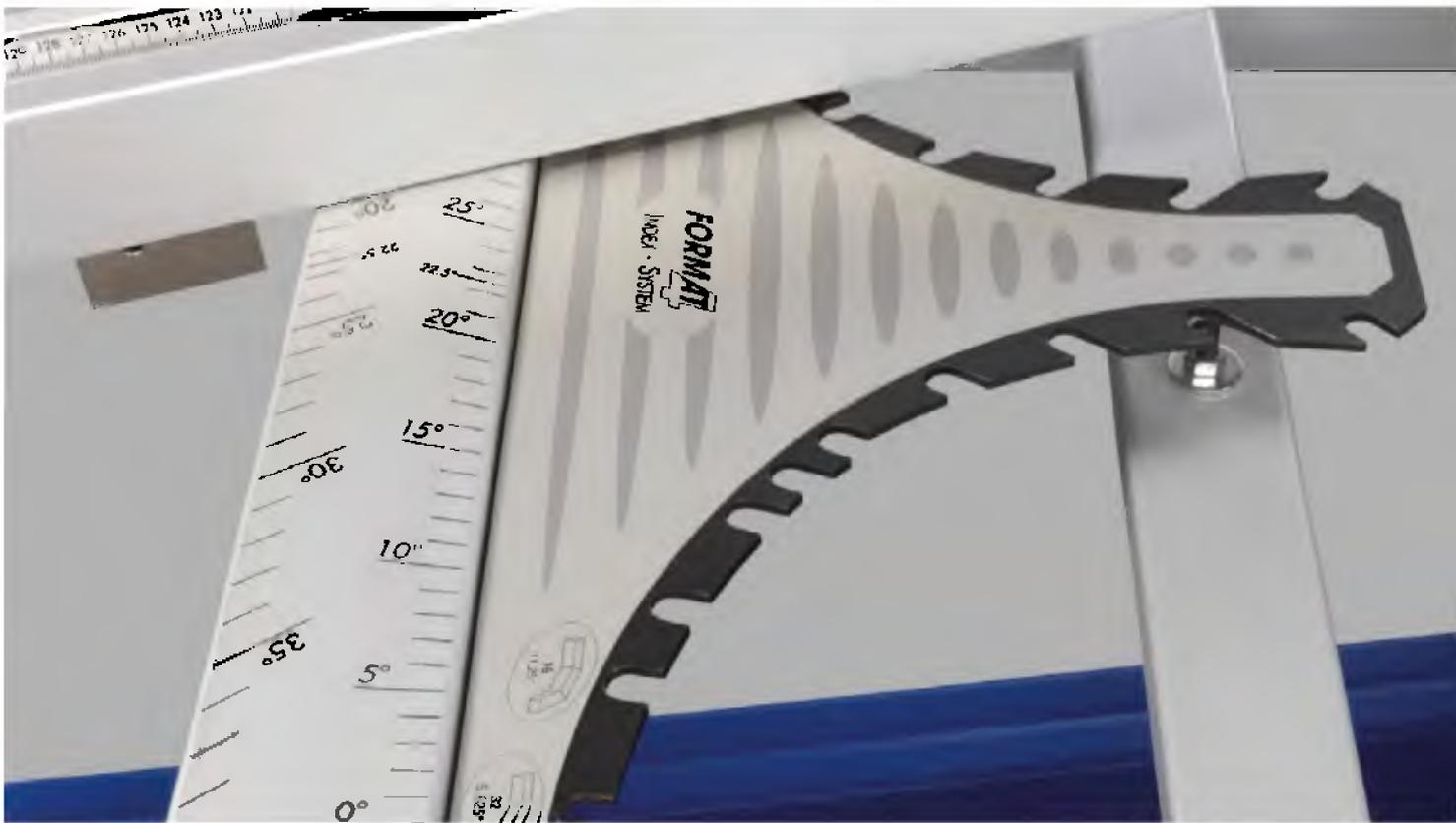

Precision mitre index system

Accurate angle adjustment with the mitre indexing system including fence length compensation

No reading errors due to scales and nonius. No lost time with painstaking cautious attempts at setting the angle value. Hundred percent accurate adjustment and setting without lost time and reading errors, these are the advantages of the precision mitre guide index system. Highly precise index points enable the exact production of polygons such as e.g. 5.625° (32 sides), 11.25° (16 sides), 22.5° (8 sides). Additional index points at 15°, 20°, 25°, 30°, 35°, 40° and 45° can be used when the crosscut fence is both at the front and at the back of the outrigger. Every index position is provided with length compensation. The highly precise mitre index system is adjusted at the factory and every index position can also be individually fine adjusted. The index system integrates itself well into the machine design and will increase your productivity for an amazingly low investment amount. (Option)

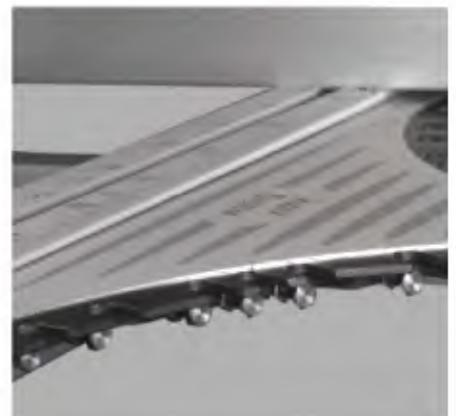

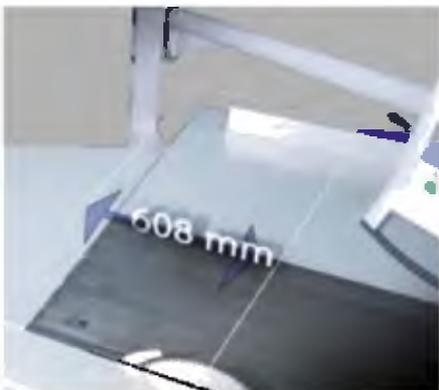

Swing away overhead saw guard

The overhead saw guard is height adjustable and can be swung away.

The average depth of particularly wide workpieces is 608 mm.

Details, that impress!



Tooling compartment

- Integrated tooling storage in the machine chassis
- Storage room for 5 saw blades, max. Ø 400 mm



Spray equipment

Your Format-4 can be optionally fitted with a spraying unit for the processing of non-ferrous metals or plastics. High performance lubricating oil can be sprayed directly onto the saw blade, transported via piping from the spraying unit.



"Easy-Lock" tool free saw blade change

The clamping system is maintenance free and offers premium comfort for many years: Change saw blades effortlessly in literally no time at all.

Technical specifications



		kappa 400	kappa 400 x-motion
Cutting height		133 mm	133 mm
Saw blade tilt		0°–45°	0°–45°
Rip capacity		800/1,250 mm	800/1,250 mm
5.5 PS (4.0 kW)		S	S
7.5 PS (5.5 kW)		O	O
Working height		890 mm	890 mm
Length [L] **	2,050 mm*	4,647	4,647
	2,500 mm*	5,547	5,547
	2,800 mm*	6,147	6,147
	3,200 mm*	6,947	6,947
	3,700 mm*	8,030	8,030
Width [W ₁]		1,074/1,509 mm	1,212/1,672 mm
Width [W ₂]		1,830–3,345 mm	1,830–3,345 mm
Weight (depending on equipment, without packaging)		930 kg	930 kg
Extraction connection-Ø saw aggregate/saw guard (overhead)		120/80 mm	120/80 mm

*Cutting length with outrigger table and at maximum cutting height, **Details of the maximum travelling distance based on the length of the sliding table; S ... Standard equipment O ... Option - ... not available



Further information about the technical data, individual configuration options and all noise level values can be found on the internet at www.format-4.com

Space requirement

Scale

1:50

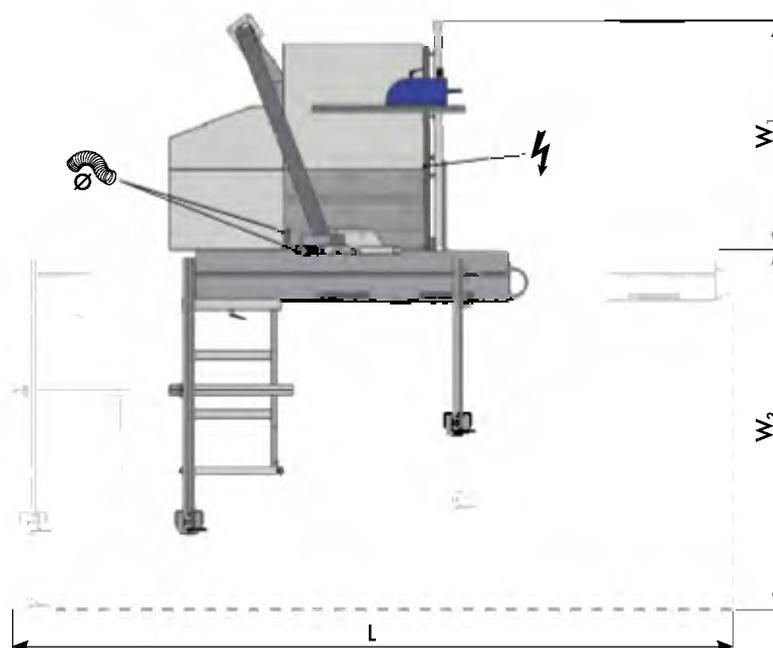

Symbolic image kappa 400, kappa 400 x-motion

Dimensions given can vary if special options are selected

plan 51L

Three metre planer table length

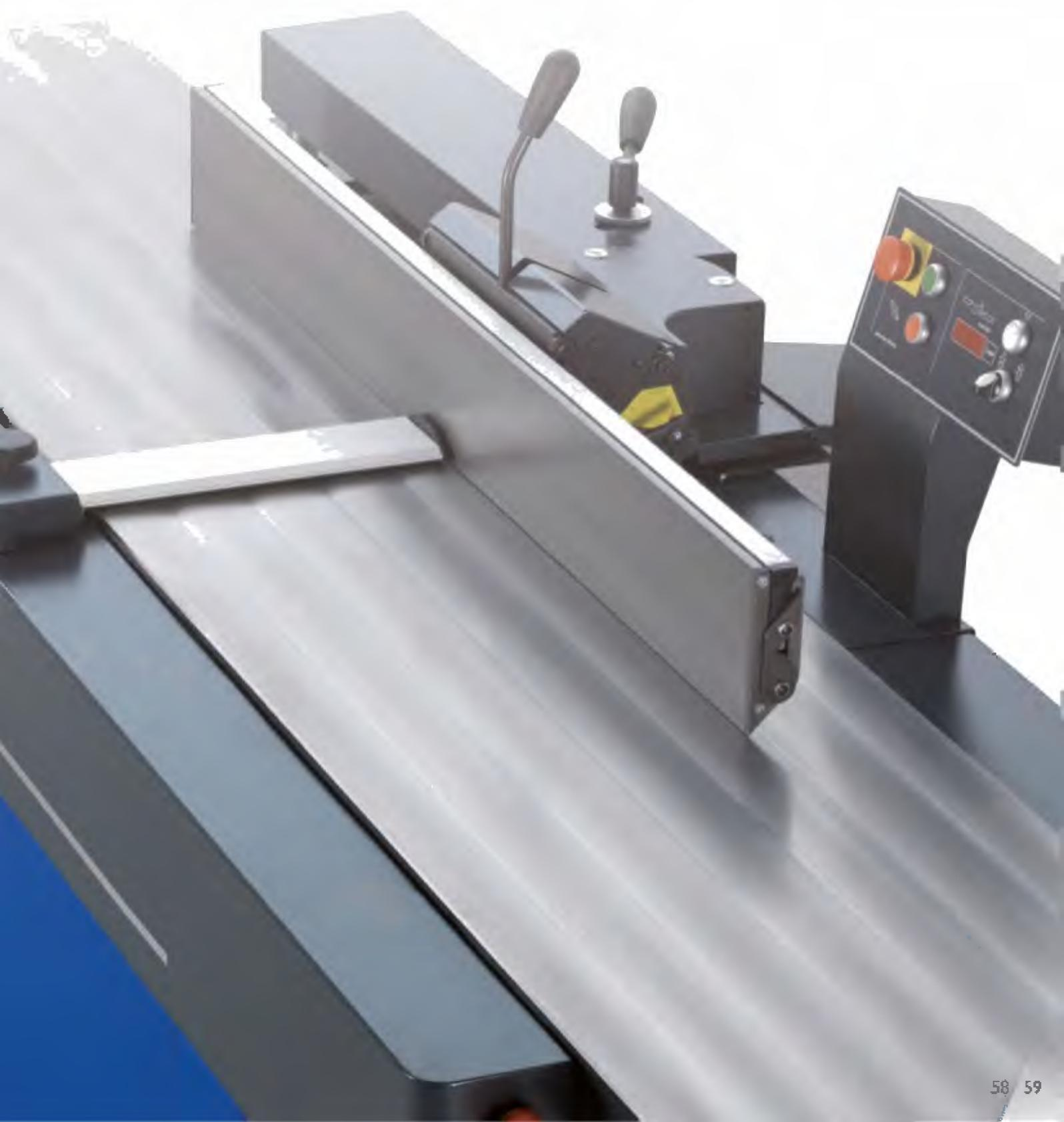

plan 51L

FORMAT

In the length
lies the strength

Long, cast iron, solid planer tables,
comfortable adjustment of the depth
of cut, tiltable planing fence and the
Format-4 system cutterblock makes
the plan 51L a planer of the top class.

**Bringing together what
belongs together.**

plan 51L + exact 63

Tip: The combination of the exact 63 thicknesser with
the plan 51L planer and the space saving planer fence
has resulted in the perfect combination.





Silent-POWER®
Spiral Cutterblock

Change the blades in
record time

3,000 mm planer
table length

Professional planer fence
with parallelogram
adjustment

Planing table adjustment
with Power-Drive

Concave and
convex joints



Revolutionary: Silent-POWER® cutterblock

Sensationally quiet planing and money saving!

Exclusive for planers from the Felder Group

The Silent-POWER® spiral cutterblock reduces noise emissions by more than half when planing. The continuous pulling cut ensures tear-free results when planing all types of wood. With this revolutionary new development from Felder you are obtaining all of the advantages of a spiral cutterblock at considerably lower operating, investment and adjustment costs.

The advantages of the Silent-POWER® cutterblock at a glance ...

- Sensationally quiet, noise emissions halved
- Blade life up to 20 times longer
- Four highly precise cutting edges on each knife
- Optimised chip extraction and reduced chip volume
- Tear-free planing results
- Reduced power consumption when compared to similar systems



Smaller chips - compact better

The optimised extraction hood ensures that the noticeably shorter chips are optimally extracted and therefore compress better in the dust bags.



Planing with a 4-knife cutterblock

The plan 51 planer with the Format-4 system cutterblock, 120 mm blade cutting diameter and 4 knives, offers performance, precision and operating comfort in a nutshell.

The Format-4 system with double-sided disposable planer knives has proved itself for decades. Perfectly manufactured and adjusted in the factory, there are no further adjustments needed and no unnecessary expensive adjusting tools are required. It's fast and easy to change the planer knives. In less than a few minutes the 4 knife cutterblock is ready for use with new sharp Format-4 knives. As an option you can also equip your Format-4 with a Silent-POWER® spiral cutterblock, or with standard or Tersa knife systems.

Planer knife setting without tools – tenth of a millimetre accuracy as standard with FORMAT-4!

- 4 knife cutterblock
- Knife change in less than two minutes
- Self-aligning knives are perfectly set each and every time
- No resin buildup on the clamping bolts
- Extremely quiet operation due to the enclosed design
- Maximum durability of the knives
- Cost saving with cheaper knife costs



Details that impress!

Planing table adjustment with Power-Drive

The high-precision planing table adjustment system provides excellent planing quality. The long, solid cast iron planing tables can be adjusted to a tenth of a millimetre at the touch of a button, using the electromotive "Power-Drive" adjustment which is included as standard and ensures maximum user comfort. The ergonomic control panel is always at eye level.

Concave and convex joints

The plan 51L is the first Format-4 planer to offer a tilt setting of the infeed planing table for the production of convex and concave pieces. With the concave or convex planed workpieces you will achieve perfect glueing results without any visible joints.





Professional planer fence

The new space saving FORMAT-4 planing fence

A masterpiece of space saving design that ensures stability and precision - the innovative Format-4 parallelogram planing fence system design allows you to be able to position your machine directly next to the workshop wall, without restricting the planing width.

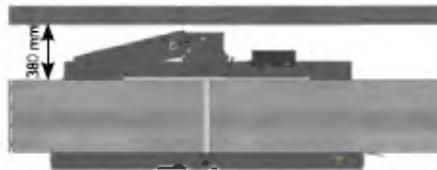

The new FORMAT-4 auxiliary fence

When processing thin or narrow workpieces the new tiltable auxiliary fence attached to the planer fence, guarantees safe and comfortable planing.



The new FORMAT-4 planer guard

Maximum operational safety and an unprecedented ease of use. The space saving planer guard integrated into the machine chassis also stabilises the workpiece when planing and bevelling the narrow edge.



Comfort planer guard

Folds in two places, this ensures that it does not restrict you whilst planing.



SUVA planer guard

The SUVA planer guard covers the entire planing area and lifts automatically when planing.

Technical specifications



	plan 51L
Planer table length	3,000 mm
Maximum depth of cut	8 mm
Planing width	510 mm
5.5 PS (4.0 kW)	S
7.5 PS (5.5 kW)	O
Height (closed)	1,270 mm
Working height	896 mm
Length [L]	3,000 mm
Width [W]	1,583 mm
Weight (depending on equipment, without packaging)	800 kg
Extraction connection Ø Planer	140 mm

S . Standard equipment O ... Option - ... not available



Further information about the technical data, individual configuration options and all noise level values can be found on the internet at www.format-4.com

Space requirement

Scale

1:50

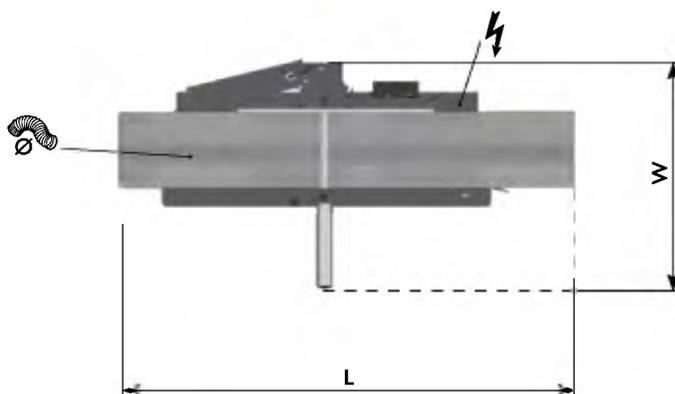

Symbolic image plan 51L

Dimensions given can vary if special options are selected

exact 51 exact 63

Power - Comfort - Precision



exact 51/63

FORMAT.

Precision and comfort for heavy use

Optimised for maximum demands, these thicknessers are a complete package of absolute top performance and precision. Innovative operating controls and large dimensioned, heavy-duty precision components with top class manufacturing quality and high durability. Tried and tested Format-4 system components such as the solid thicknessing bed, exact setting accuracy and the four trapezoidal spindles combine together with innovative new developments such as the Silent-POWER® spiral cutterblock to offer a whole new dimension of planing finish quality. Professional machine operators from small and big workshops all the way through to industry profit from perfect planing results.





Silent-POWER®
Spiral Cutterblock

Change the blades
in record time

"Digi-Drive"
Full electronic
adjustment

Variable adjustable
feed rate 5–20 m/min

Rubber rollers
segmented pressure bar

Scissor lifting table



exact 5 l

Cutterblock housing

The cast iron cutterblock housing can easily handle any type of work. As an option, the machine can be equipped with rubber coated in and outfeed rollers, for the problem free processing of workpieces with different thicknesses.

Segmented pressure beam at the infeed

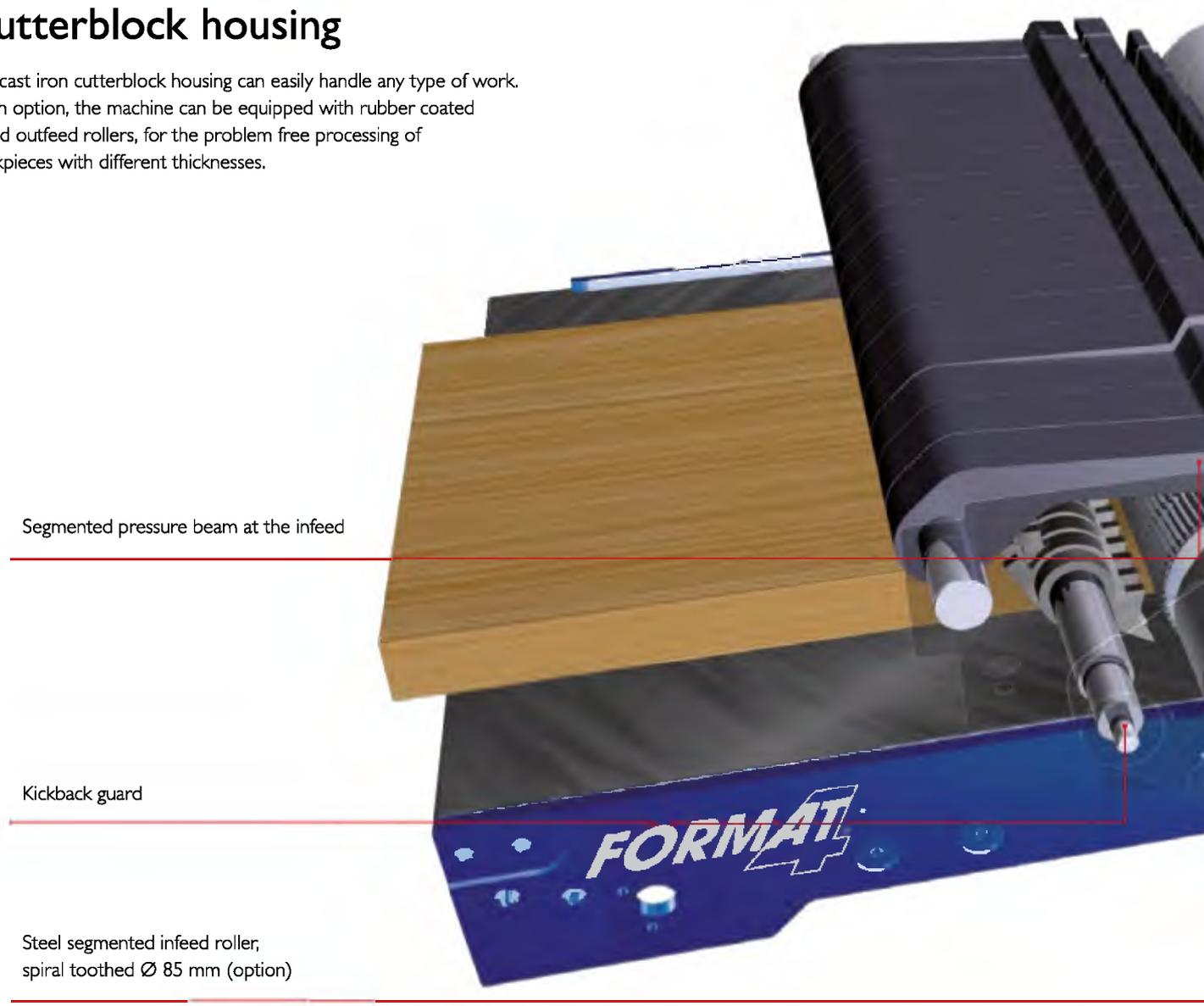

Kickback guard

Steel segmented infeed roller,
spiral toothed Ø 85 mm (option)

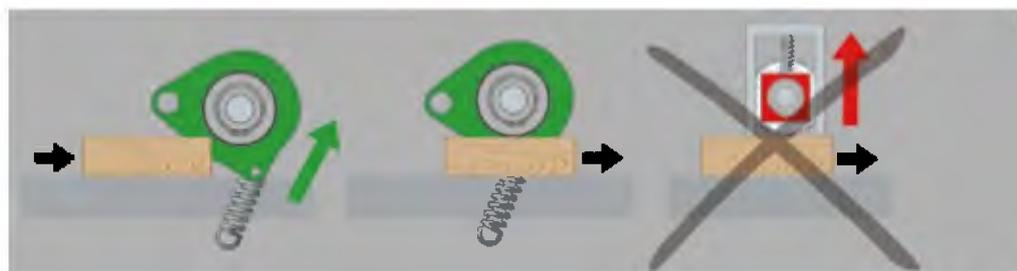

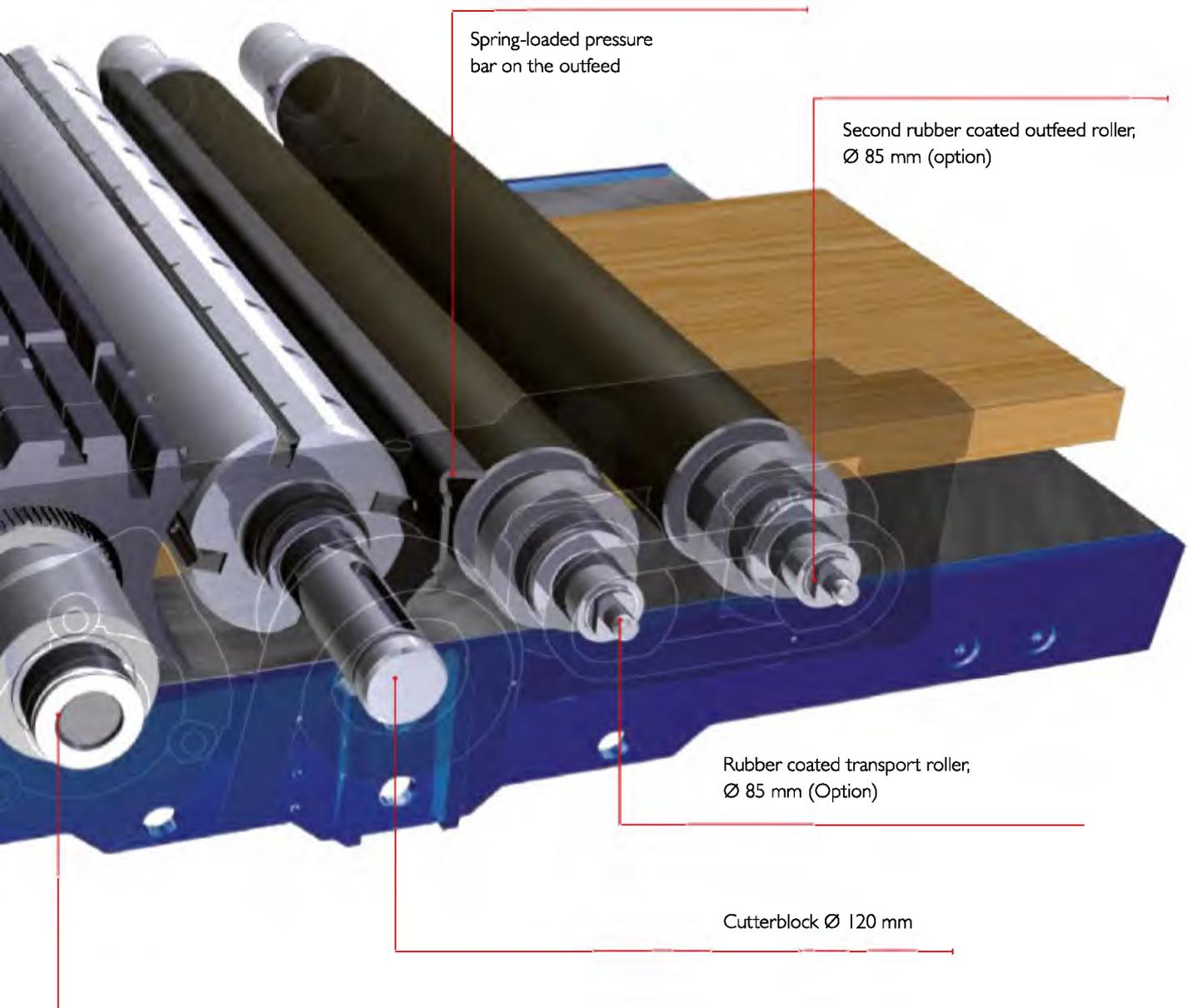

Infeed rollers

The infeed rollers are suspended which allows them to lift gently when processing with a large depth of cut.

There are 3 different different infeed roller options available:

- A spiral toothed infeed roller guarantees a smooth transport of the workpiece, with maximum traction.
- A rubber coated roller (exact 63) is ideal for the gentle feeding of particularly thin workpieces or when planing with a small depth of cut. Workpieces with a small thickness difference can be processed simultaneously.
- A segmented steel infeed roller can balance out different wood thicknesses without a problem. The spiral tooth design guarantees maximum feed traction and is practically wear and tear resistant.

The pressure roller on the infeed side is segmented. Every segment is spring loaded and can move individually to the other segments.

This guarantees an optimal pressure on every workpiece size.

Outfeed rollers

A sand-blasted steel feed roller ensures an optimal contact pressure and transport of the workpiece on the outfeed side. For larger cross sections and wide workpieces a second driven outfeed roller is available as an option. By using a second outfeed roller, the workpiece feed through the machine can be considerably improved, especially when processing large workpieces or problematic material (materials with high frictional resistance) and when no lubrication is used. For a perfect surface finish, we recommend a rubber outfeed roller.



Planer knives

Four different knife systems to choose between

→ **4 knife system cutterblock**

Planer knife setting without tools –

tenth of a millimetre accuracy as standard with Format-4!

- 4 knife cutterblock
- Knife change in less than two minutes
- Self-aligning knives are perfectly set each and every time
- No resin buildup on the clamping bolts
- Extremely quiet operation due to the enclosed design
- Maximum durability of the knives
- Cost saving with cheaper knife costs

→ **4 knife TERSA-system cutterblock**

→ **4-knife standard cutterblock**



Revolutionary: Silent-POWER® cutterblock

Sensationally quiet planing and money saving!

Exclusive for planers from the Felder Group

The Silent-POWER® spiral cutterblock reduces noise emissions by more than half when planing. The continuous pulling cut ensures tear-free results when planing all types of wood. With this revolutionary new development from Felder you are obtaining all of the advantages of a spiral cutterblock at considerably lower operating, investment and adjustment costs.

The advantages of the Silent-POWER® cutterblock at a glance...

- Sensationally quiet, noise emissions halved
- Blade life up to 20 times longer
- Four highly precise cutting edges on each knife
- Optimised chip extraction and reduced chip volume
- Tear-free planing results
- Reduced power consumption when compared to similar systems



Smaller chips - compact better

The optimised extraction hood ensures that the noticeably shorter chips are optimally extracted and therefore compress better in the dust bags.

Controls exact 63 + exact 51



... with "Power-Drive" - everything is electrical
Turn knob for quick adjustments, push button for fine adjustments. The LED display shows the actual values.



... and with "Digi-Drive" - just type it in
Enter the thickness required, press Start and the thickening bed adjusts exactly to the desired position. LED displays for the required and actual values. Additional functions: incremental adjustments, 4 programmable thickening table positions.

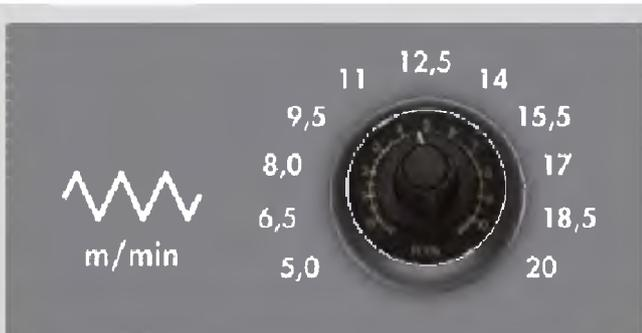

Feeder device

Variable feed speed of between 5–20 m/min.

Whether its a perfect finish or quick thickness calibration that is required, the correct feed speed can always be set to match.

Details that impress!

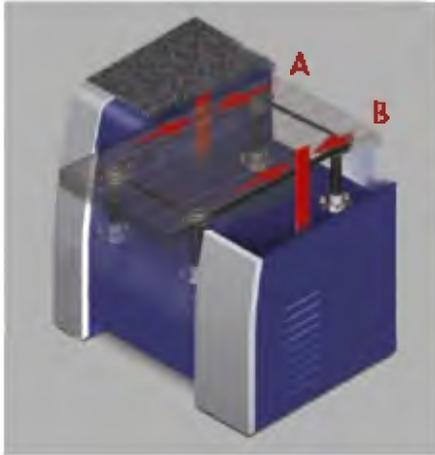

Outstanding stability and long-lasting precision

Four trapezoidal support spindles ensure maximum precision and high load bearing capacity. Vertical guides integrated into the side of the machine chassis absorb the resulting outfeed side pressure and guide the thickening table into position with an accuracy of a tenth of a millimetre.



Optional: Adjustable under table rollers



For those customers that regularly process wet or resinous wood, we would recommend the option of the workpiece roller with automatic lubrication on the infeed side of the machine.



Increased comfort: Stable table extensions with workpiece roller on the outfeed side.



Scissor lifting table

For especially large and heavy workpieces there is a scissor lifting table with a length of 1,150 mm available. The scissor lifting table moves together with the thickening table.

Technical specifications



	exact 51	exact 63
Maximum depth of cut	10 mm	10 mm
Thickening width	504 mm	630 mm
Thickening table length	900 mm	1,050 mm
Min.-max. thickening height	3–300 mm	3–300 mm
5.5 PS (4.0 kW)	S	-
7.5 PS (5.5 kW)	○	S
10.0 PS (7.35 kW)	○	○
15.0 PS (11.0 kW)	-	○
Height (closed)	1,170 mm	1,193 mm
Height (open)	1,900 mm	1,950 mm
Length [L]	1,113 mm	1,226 mm
Width [W]	1,000 mm	1,262 mm
Weight (depending on equipment, without packaging)	800 kg	1,000 kg
Extraction connection Ø thickener	140 mm	160 mm

S ... Standard equipment ○ ... Option - ... not available



Further information about the technical data, individual configuration options and all noise level values can be found on the internet at www.format-4.com

Space requirement

Scale
1:50

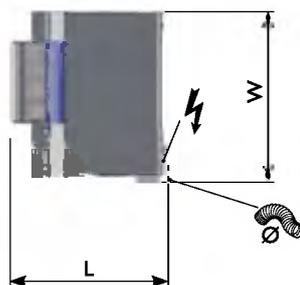

Symbolic image exact 51, exact 63

Dimensions given can vary if special options are selected

dual 51

Absolute precision at the touch of a button



dual 51

FORMAT

Uncompromisingly strong, the surface planer thicknesser combination for highly demanding tasks

The well laid out machine design displays the key competences of the new Format-4 planer at first glance: Stability, reliability and operating comfort of the highest level. The intuitive Format-4 operating concept offers extreme comfort and maximum efficiency. Moving from planing to thicknessing with the dual 51 can be done in just a few steps or at the touch of a button with the quickest changeover times of its class.





Silent-POWER®
Spiral Cutterblock

Synchronous opening
of the planing tables

Change the blades in
record time

Electric
automatic changeover

Variable adjustable
feed rate 4-16 m/min

"Digi-Drive"
Full electronic
adjustment

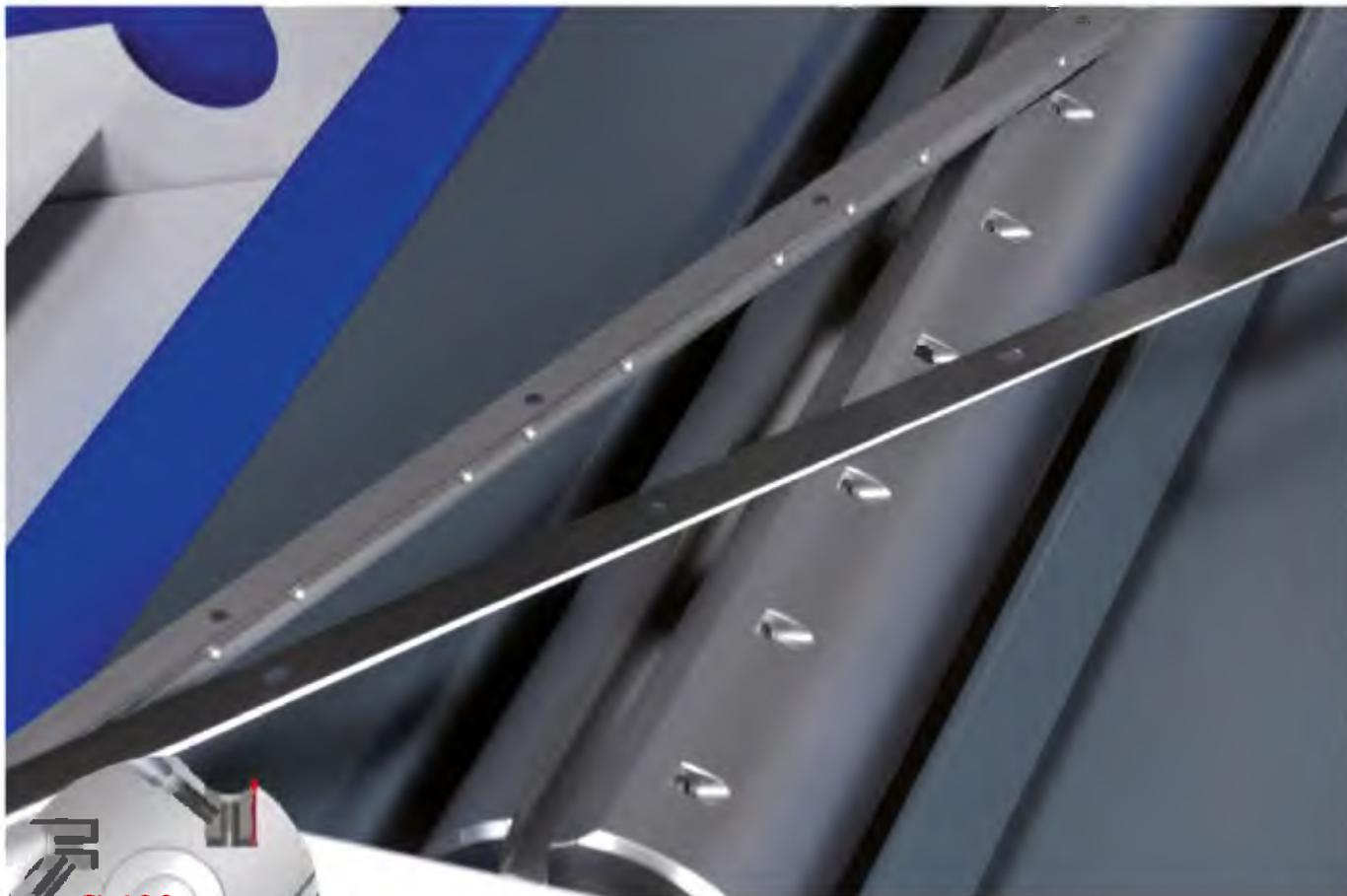

4-knife cutterblock

See and feel the incredible smooth finish!

The Format-4 system with double-sided disposable planer knives has proved itself for decades. Perfectly manufactured and adjusted in the factory, there are no further adjustments needed and no unnecessary expensive adjusting tools are required.

It's simple to change the planer knives. In less than a few minutes the 4 knife cutterblock can be fitted with sharp Format-4 planer knives that are set and ready to use! With an 120 mm knife cutting diameter, 4 knives and the unique system cutterblock technology, the planed finish from Format-4 reaches a new higher level. As an option you can also equip your Format-4 with a Silent-POWER® spiral cutterblock, or with Standard or Tersa knife systems.

Planer knife setting without tools – tenth of a millimetre accuracy as standard with FORMAT-4!

- 4 knife cutterblock
- Knife change in less than two minutes
- Self-aligning knives are perfectly set each and every time
- No resin buildup on the clamping bolts
- Extremely quiet operation due to the enclosed design
- Maximum durability of the knives
- Cost saving with cheaper knife costs



Revolutionary: Silent-POWER® cutterblock

Sensationally quiet planing and money saving!

Exclusive for planers from the Felder Group

The Silent-POWER® spiral cutterblock reduces noise emissions by more than half when planing. The continuous pulling cut ensures tear-free results when planing all types of wood. With this revolutionary new development from Felder you are obtaining all of the advantages of a spiral cutterblock at considerably lower operating, investment and adjustment costs.

The advantages of the Silent-POWER® cutterblock at a glance ...

- Sensationally quiet, noise emissions halved
- Blade life up to 20 times longer
- Four highly precise cutting edges on each knife
- Optimised chip extraction and reduced chip volume
- Tear-free planing results
- Reduced power consumption when compared to similar systems



Smaller chips - compact better

The optimised extraction hood ensures that the noticeably shorter chips are optimally extracted and therefore compress better in the dust bags.

dual 51 control



... with "Power-Drive" - everything is electrical
Turn knob for quick adjustments, push button for fine adjustments. The LED display shows the actual values.



... and with "Digi-Drive" - just type it in

Enter the thickness required, press Start and the thickening bed adjusts exactly to the desired position. LED displays for the required and actual values. Additional functions: incremental adjustment, 4 programmable thickening table positions.

Individual feed speed

Regardless of the type of wood and grain, the variable feed speed of between 4-16m/min always guarantees a perfect thickening result.

Details, that impress!

Four trapezoidal support spindles ensure utmost precision and high load bearing capacity. Vertical guides integrated into the side of the machine chassis absorb the resulting outfeed side pressure and guide the thickening table into position with an accuracy of a tenth of a millimetre. Optional: Integrated adjustable rollers for the processing of workpieces with high resin or moisture content.



Extraction hood: Heavy chip loads are no problem for the chip extraction hood due to its efficient design and large dimension.

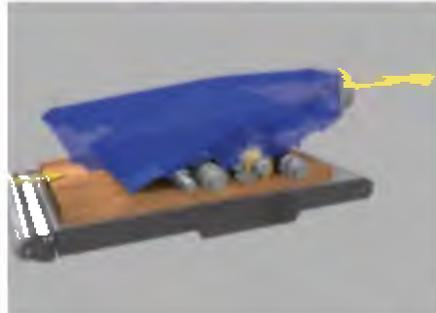

Two pressure bars prevent the fluttering of the workpiece, in particular thinner pieces when thickening.



The optional rubber infeed and outfeed transport rollers are highly recommended when working with difficult, very thin or different thickness workpieces and those jobs requiring minimal final thickness. On request, we can provide a spring-loaded, segmented infeed pressure bar, combined with infeed rubber roller for simultaneous processing of timber of varying thickness.

FORMAT®



Intuitive, synchronised opening of the dual planing table

The tried and tested Format-4 operating concept reduces the effort in changing from planing to thicknessing to a minimum. The intuitive table clamping system makes it possible to synchronously unlock and lift the planing tables with one hand movement, industrial springs assist in the opening.



The new electric automatic changeover

That is first class operating comfort: At the touch of a button you can open and close the planing table when changing from planing to thicknessing and vice versa.



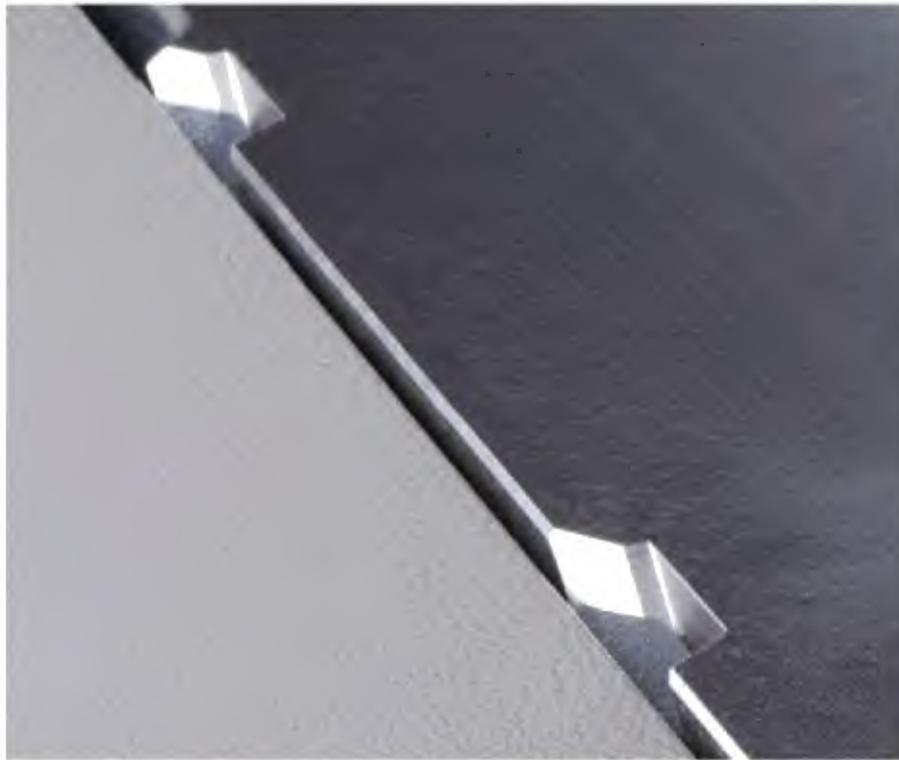

Patented planer adjustment system

Adjustment precision. This is ensured by the patented planing table adjustment system which has prismatic guides.



With the new ergonomically shaped depth of cut adjustment handle, you can adjust the depth of cut quickly and precisely.



The depth of cut can be adjusted and set at any position up to 8 mm. The integrated lens makes it possible to accurately read the setting, ensuring exact results.

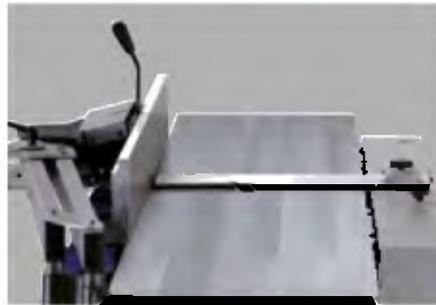
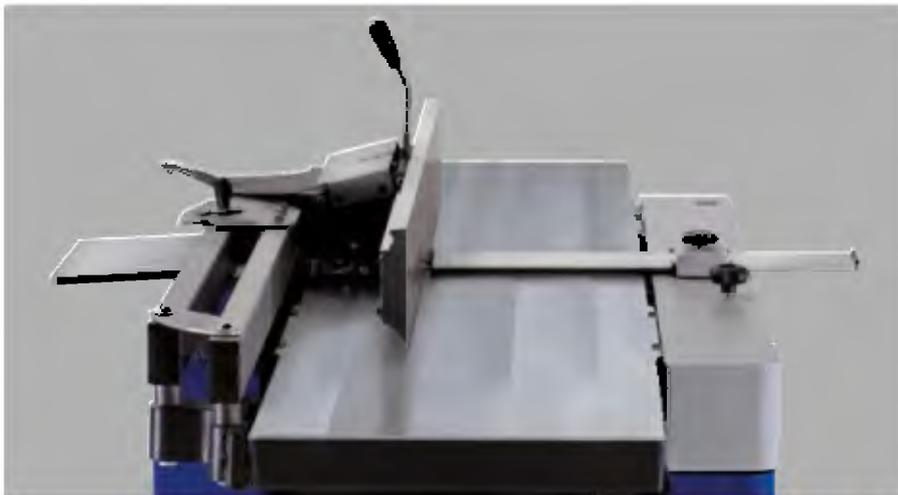

The new space saving FORMAT-4 planing fence

A masterpiece of space saving design that ensures stability and precision - the innovative Format-4 parallelogram planing fence system design allows you to be able to position your machine directly next to the workshop wall, without restricting the planing width.

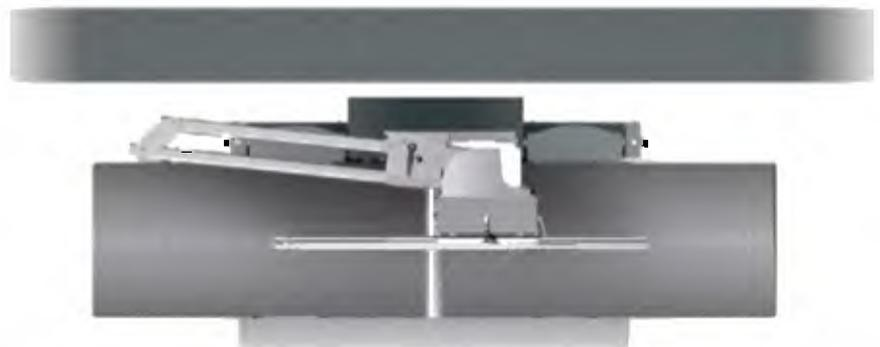



The FORMAT-4 planer guard

Maximum operational safety and an unprecedented ease of use. The space saving planer guard integrated into the machine chassis also stabilises the workpiece when planing and bevelling the narrow edge.

Comfort planer guard

Folds in two places, this ensures that it does not restrict you whilst planing.



Aigner combination fence

The auxiliary fence is built into the Aigner combination fence ensuring that it does not get in the way when the fence is at an angle. Always at hand when required.

Technical specifications



	dual 5 I
Planer table length	2,250 mm
Max. depth of cut planer/thicknesser	8/8 mm
Surface planing width	510 mm
Thicknessing width	504 mm
Thicknessing table length	900 mm
Min.-max. thicknessing height	3–254 mm
5.5 PS (4.0 kW)	S
7.5 PS (5.5 kW)	○
10.0 PS (7.35 kW)	○
Height (closed)	1,270 mm
Height (open)	1,650 mm
Working height	890 mm
Length [L]	2,252 mm
Width [W]	965–1,642 mm
Weight (depending on equipment, without packaging)	870 kg
Extraction connection Ø planer/thicknesser	140 mm

S ■ Standard equipment ○ ■ Option - ■ not available



Further information about the technical data, individual configuration options and all noise level values can be found on the internet at www.format-4.com

Space requirement

Scale
1:50

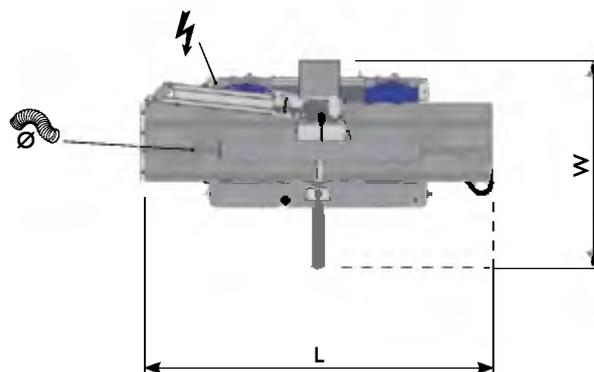

Symbolic image dual 5 I

Dimensions given can vary if special options are selected

profil 45 Z profil 45 M

Power package with premium comfort



profil 45 Z

FORMAT

Top class moulding comfort

Elegant, perfectly designed and intelligent - the Format-4 profil 45 Z offers perfection at the push of a button regardless of the operation. The highlights for the professional user: Height and angle adjustment of the spindle as well as the positioning of the spindle fence can be quickly and easily adjusted from the control panel. Spindle quick change system - quick changeover times and maximum flexibility. Premium woodworking of the highest level with quality from Austria.



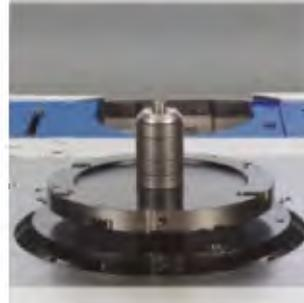

"Easy-Glide"
tilting guide system

Moulder spindle
quick change system

Table opening:
320 mm

Rearward tilting
spindle

Spindle fence with tilt
away function

"X-Roll" slot and
tenoning table



profil 45 Z

profil 45 M

FORMAT.

The powerhouse
with premium
comfort



The new high tech tilting spindle moulder from Format-4 offers top quality Austrian machine manufacturing precision with elegant design, premium operating comfort and innovative detailed solutions. Stability and high performance even when pushed to the limit: The solid, highly precise cast iron table guarantees maximum stability and completely vibration-free processing even when under maximum load. The 7" TFT colour monitor in the "x-motion" package offers unique, top class operating comfort. The touch screen user control is at eye level and shows all the important information on one screen.



profil 45 M



"Easy-Glide"
tilting guide system

Moulder spindle
quick change system

Table opening:
320 mm

Rearward tilting
spindle

Electrically adjustable
fence

Spindle fence with tilt
away function

The spindle moulder unit

The profil 45 spindle moulder unit leaves nothing to be desired!

Every detail of the heavy duty profil 45 spindle moulder reflects decades of engineering combined with the most up-to-date technology.

The powerful profil 45 spindle moulder unit has been specially developed for industrial use. With the precision dual guidance ensuring exact angle adjustments and the dovetail guiding system guaranteeing exact linear height adjustment, you are assured accurate settings for many years to come.

- Moulder spindle useable height of up to 140 mm Ø 30 mm
(160 mm for Ø 40 and 50 mm)
- Table opening 320 mm
- Quick change system for moulder spindle
- Change of speed from front of machine
- Collet chuck spindle for router tools with a speed of 15,000 rpm (optional)
- Electronic height adjustment with digital LED display
- Electronic angle adjustment with digital LED display
- Rearward tilt 0° to 45° / 5° forwards with x motion
- Dovetail guidance system of the height adjustment
- Maximum power transmission achieved through the large surface of the POLY-V belts
- 3 bearing seats for the moulder spindle
- Excellent vibration absorption with heavy cast iron unit
- **6 year guarantee** on "Easy-Glide", the FORMAT-4 tilting segment guide!
 - Maximum load bearing capacity
 - Play-free tilt
 - Unaffected by dust
 - Completely maintenance free
 - Completely lubrication free



Tilt segment "Easy-Glide"



The spindle unit with precision double suspension is guided within solid cast iron tilting segments. The "forced" guiding system ensures precision and repeatable accuracy of settings.

Maximum power transmission achieved through the large surface of the POLY-V belts.



"Power-Drive" control

The "Power-Drive" package offers maximum user comfort ensuring that the height and angle adjustment of the spindle moulder can be quickly and precisely electronically controlled. The quick settings can be adjusted at the turn of a knob and the fine adjustment is carried out at the push of a button. Red LED digits display the current position in real time on the control panel.



Spindle fence control

With precise quick adjustment (depending on the machine configuration either directly on the spindle fence or from the optional overhead touch screen) the spindle fence is electrically adjustable and the current setting is displayed in real time.



"x-motion" control

Top class operating comfort

An absolute highlight of the "x-motion" package is the 7" TFT colour monitor for unique operating comfort that is top class. The touch screen user control is at eye level and shows all the important information on one screen. Along with all of the moulder spindle settings, the Format-4 spindle fence can also be controlled directly from the touch screen. The premium quality offers maximum efficiency with the possibility to load programs at the touch of a button, with individually configurable moulding programs and the tooling database.

- 7" TFT colour monitor built into the overhead panel
- Touch screen control
- Precision positioning of the spindle fence
- Spindle height and angle control at the touch of a button
- Specific configurable moulding programs
- Individual user administration
- Tool database
- Quick referencing of the spindle height and angle after changing the tool
- Correction of the spindle height and fence following an adjustment of the angle
- Changing between absolute and incremental values

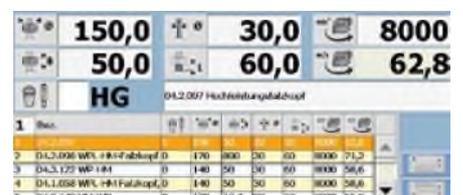
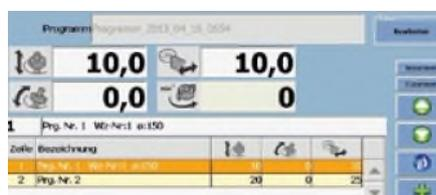
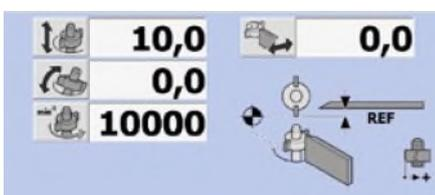
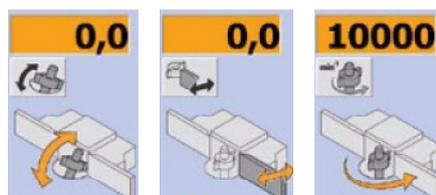



Moulder spindle

Quick change system for moulder spindle

The almost unlimited applications of your new profil 45 tilting spindle moulder is enhanced even further by the spindle quick change system. Spindles with pre-mounted tools for serial moulding work and spindles with differing diameters can be changed over in seconds. A particular highlight is the high speed router spindle for router tools with a rpm of 15,000. For maximum stability and durability, Format-4 spindles have been designed with 3 sets of high quality, high precision bearings!

Advantages of the quick change system:

- Quick, easy change between different types of spindles
- Ability to use 30, 32, 35, 40, 50 mm and 1 ¼" diameter spindles
- Use of the Format-4 high speed router spindle for router bits or high speed tools at 15,000 rpm
- Automatic repeatable setting for series production work



Save valuable production time with the moulder spindle quick change system and premium operating comfort

Take full advantage of the technology that Format-4 has to offer with incredibly quick tool changes and setting adjustments. The spindle can be changed in seconds and together with the user friendly control system you are guaranteeing maximum efficiency with every type of work.

The "Power-Drive" control included as standard, makes it possible to set the spindle height and angle, accurate to a tenth of a millimetre quickly and with fine adjustment. With the premium control system on the profil 45 M x-motion, all of the settings can be done quickly and precisely using the 7" TFT-colour display with touch screen. The tooling database and unlimited number of programmable programs offer additional operating comfort. Along with all of the spindle settings, the Format-4 spindle moulder fence can also be positioned at the push of a button.

With machine technology from Format-4 you will always be one step ahead of the competition!

The high speed router spindle takes all router shaft diameters of \varnothing 6–16 mm. Rotational speed of 15,000 rpm, with full motor power of up to 10 HP.



The moulder spindle tilts rearwards: An important operating advantage for you!

With Format-4: Correct spindle tilting
"rearwards" with maximum operating comfort

- Work safely
- Suitable for any workpiece size
- Problem-free power feeder use
- Impeccable machined surface
- Optimal chip removal



**Forward tilting of the spindle moulder can be
dangerous and has serious handling disadvantages**

- Increased risk of accidents
- Limited height of workpiece
- Power feeder operation is not possible
- Inferior workpiece finish
- Poor or even impossible chip removal



Spindle fence

Precise adjustments have never been so easy

The high level of standard equipment guarantees you maximum precision, excellent operating comfort and quick setup:

- Electrical, parallel spindle fence positioning at the turn of a knob
 - Electrical fine adjustment to one tenth of a millimetre at the touch of a button
 - LED display for precise reading of measurement and a reset function
 - The removable fence plates can be adjusted between -10 and +35 mm
-
- Tooling with a Ø of up to 250 mm
 - The complete spindle fence can be tilted away below the table level
 - Centrex spindle moulder guard
 - Dual extraction from the spindle fence and below the table surface

Hard anodised aluminium fence plates are standard. The removable outfeed fence plates can be finely adjusted using the scale to any position between -10 and +35 mm.

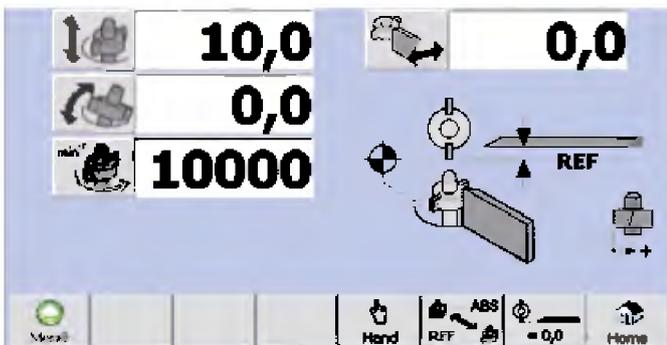

Spindle fence control via touch screen

With the profil 45 x-motion, positioning the fence is done simply and precisely using the centrally located TFT colour display with 7" touch screen. Increase your efficiency and productivity in series production with adjustments being made in seconds and repeatability always guaranteed.



Details, that impress!

Standard: Spindle fence
with tilt away function

Important for productive, quick
changing of tools and spindles
as well as for curve moulding.

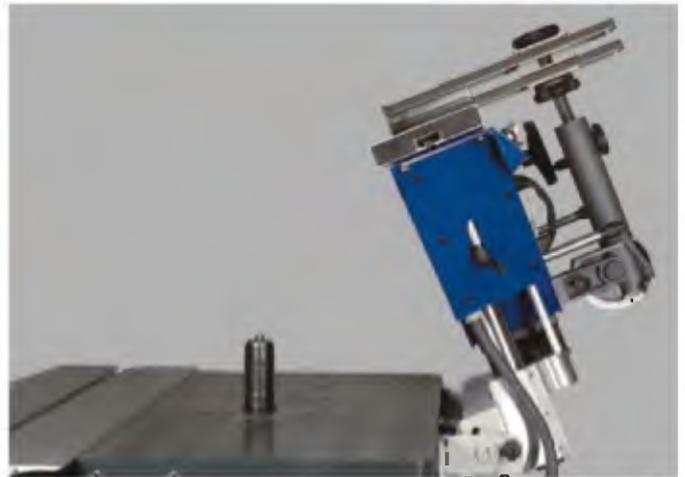
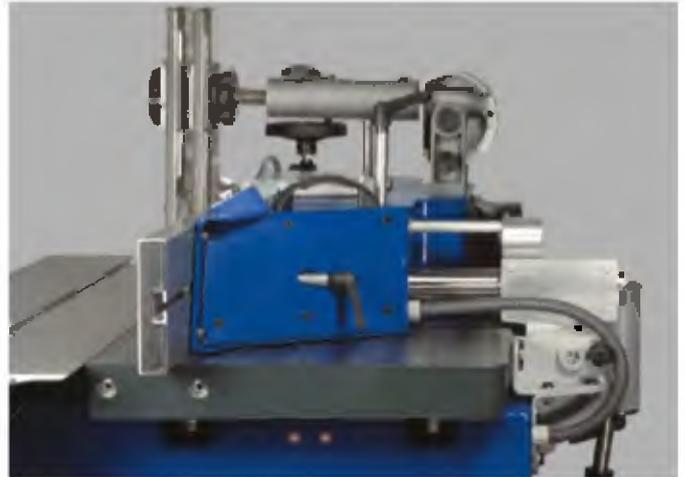

Swing away device for power feeders

The swing away power feeder arm provides
maximum operating convenience. The power
feeder remains on the machine and does not
need to be removed.

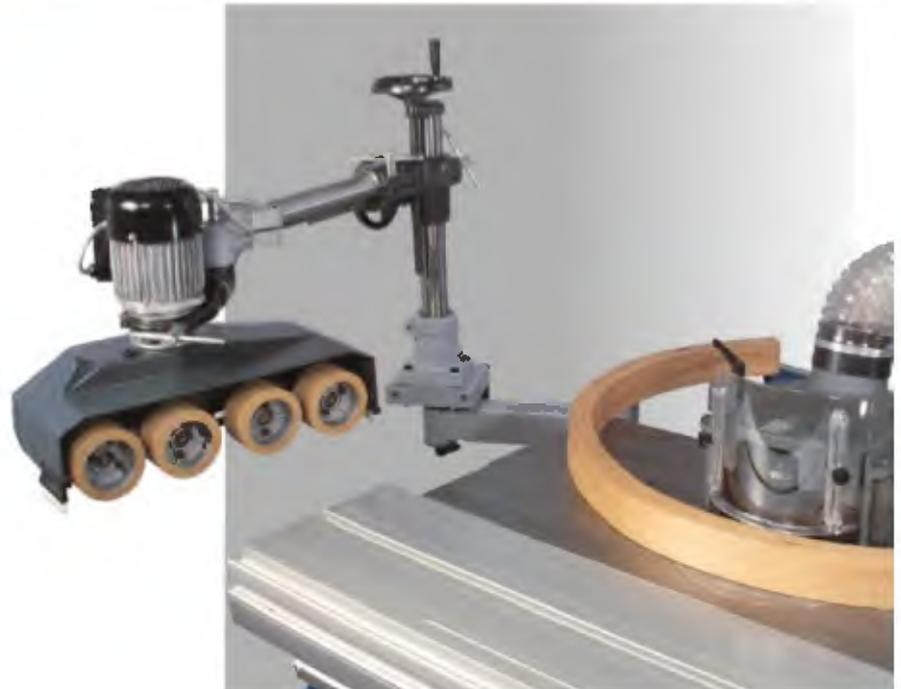



Safety bar guides

Safety bar guides for continuous workpiece guiding along the spindle fence (optional).

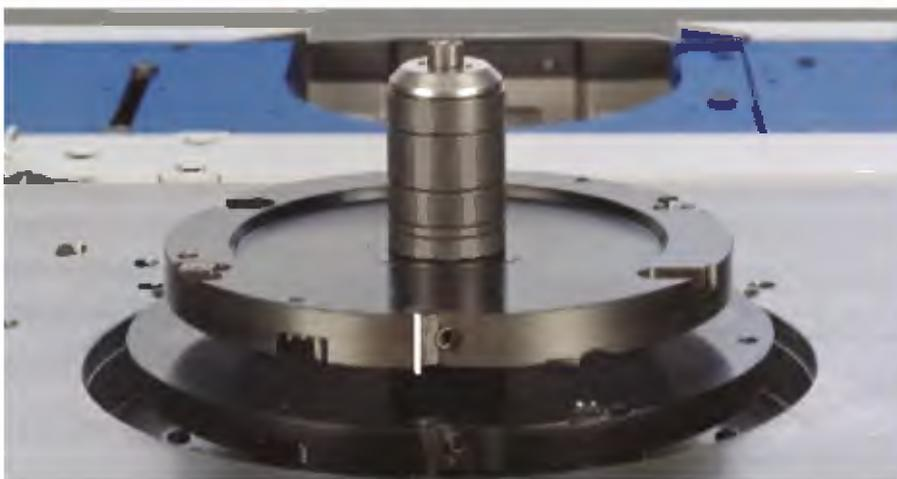
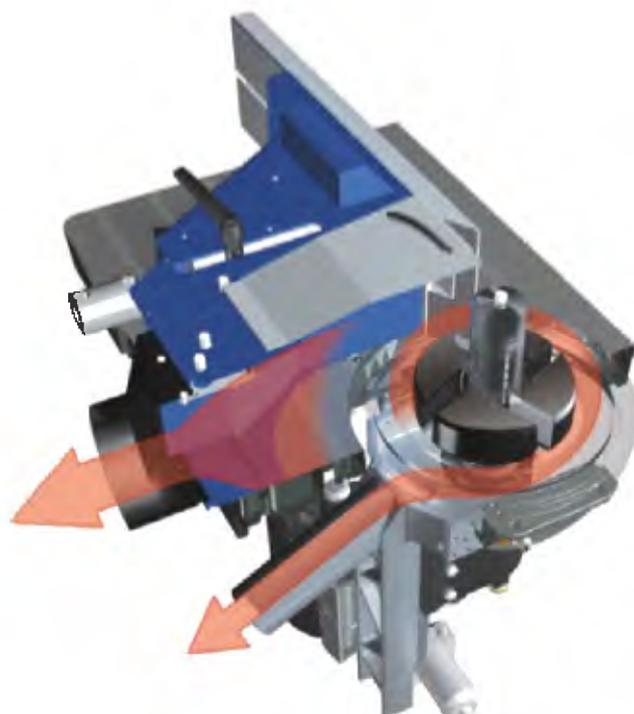

Table opening: 320 mm

The large spindle table opening offers you maximum working safety: Large dimensioned panel raising tools as well as slot and tenoning tooling can be used below the table surface.



Spindle moulder extraction

The dual extraction from the spindle fence and chip collector ensures that the machine stays clean and dust free.

FORMAT



Slot and tenons

Large dimensioned and designed for maximum load bearing capacity, the aluminium format sliding table "hovers" on the "X-Roll", a highly developed guiding technology. The X shape ("X-Roll") design of the rollers distributes the load optimally on all sides. The linear surface of the steel rollers running on the hardened and ground guiding surface guarantees unbeatable precision and smoothness. "X-Roll" will guarantee you the quality and precision that you expect from your new tilting spindle moulder. Another reason to choose Format-4: 10 year factory guarantee to underline the reliability of "X-Roll".



The outrigger table

Simple processing of larger workpieces with the FORMAT-4 outrigger tables.



Outrigger table 1,100 mm

The outrigger table makes it much easier to process large and heavy workpieces when using the sliding table. There are eight ball bearing guide rollers in the outrigger telescopic arm for maximum precision and smoothness.



Outrigger table 1,300 mm

The 1,300 outrigger table offers an optimum surface for large workpieces. The workpiece roller at the end of the outrigger guarantees the smooth loading of workpieces. Large doors can be processed on all sides for example, when using the outrigger in combination with the 2,500 mm slot and tenoning table.

Stability and high performance even when at maximum load

The solid, highly precise cast iron table guarantees maximum stability and a complete vibration-free process even when at maximum load.

Additional, adaptable support surface

The 1,270 mm long stable front pull out support quickly and easily increases the support surface by up to 400 mm. The emergency off switch is mounted to the front of the pull out for maximum operating safety and is always within reach.

670 mm table extension with 2,200 mm front pull out support

Increase the working surface area of your profil 45 M by 670 mm on both sides with the solid table extensions. A suitable extended front pull out support (2,200 mm) is also included.



Technical specifications



	profil 45 Z	profil 45 Z x-motion	profil 45 M	profil 45 M x-motion
Table opening	320 mm	320 mm	320 mm	320 mm
Moulder spindle tilt	90°-45°	+5°-45°	90°-45°	+5°-45°
Ø 30 mm spindle shaft	S	S	S	S
Speeds 3,500/4,500/6,000/8,000/10,000 rpm	S	S	S	S
Variable speed control up to 10,000 rpm	O	O	O	O
High-speed router spindle 15,000 rpm	O	O	O	O
5.5 PS (4.0 kW)	S	S	S	S
7.5 PS (5.5 kW)	O	O	O	O
10.0 PS (7.35 kW)	O	O	O	O
Working height	890 mm	890 mm	890 mm	890 mm
Machine table	970 x 442 mm	970 x 442 mm	1,160 x 770 mm	1,160 x 770 mm
Length [L ₁]	-	-	1,160 mm	1,160 mm
Length [L ₂]	-	-	2,500 mm	2,500 mm
Length [L ₃] **	1,300 mm*	2,872 mm	-	-
	2,050 mm*	4,610 mm	-	-
	2,500 mm*	5,510 mm	-	-
Width [W ₁]	1,294 mm	1,294 mm	1,172 mm	1,172 mm
Width [W ₂]	1,522/2,288 mm	1,522/2,288 mm	323 mm	323 mm
Weight (depending on equipment, without packaging)	650 kg	650 kg	730 kg	730 kg
Extraction connection-Ø Spindle fence/spindle aggregate below table level	140/80 mm	140/80 mm	140/80 mm	140/80 mm

*Moveable distance with outrigger table at maximum cutting height, **Details of the maximum travelling distance depending on the length of the sliding table. S ... Standard equipment O ... Option - ... not available E ... not possible to retrofit



Further information about the technical data, individual configuration options and all noise level values can be found on the internet at www.format-4.com

Space requirement

Scale
1:50

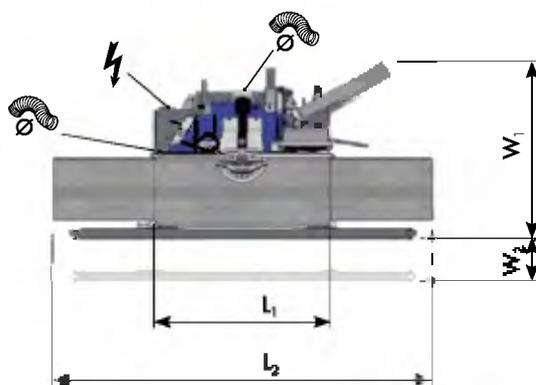

Symbolic image profil 45 M, profil 45 M x-motion

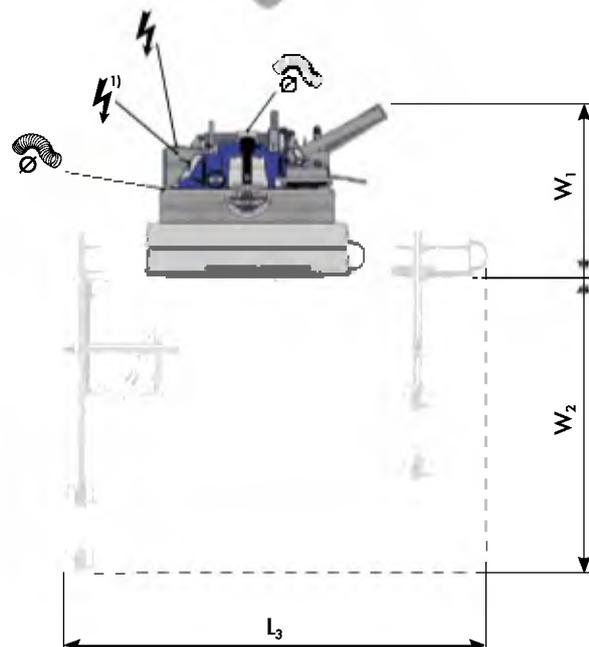

Symbolic image profil 45 Z, profil 45 Z x-motion

¹⁾ Power connection (option)

Dimensions given can vary if special options are selected

Visit us online and discover more about:

- Machines
- Videos
- Current promotions
- Tooling and accessories
- All technical information



www.format-4.com

FORMAT

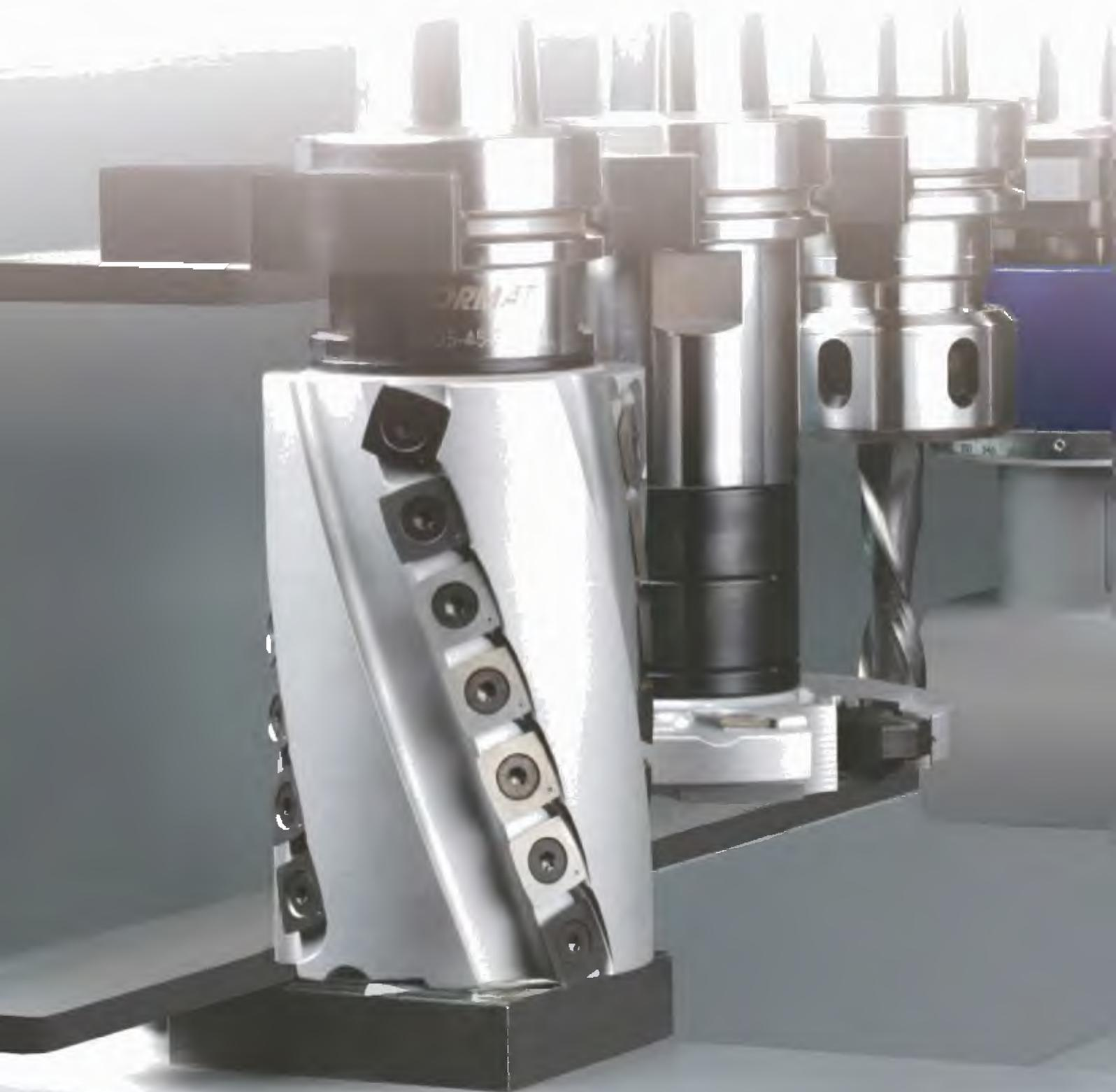

CNC

The revolution in woodworking

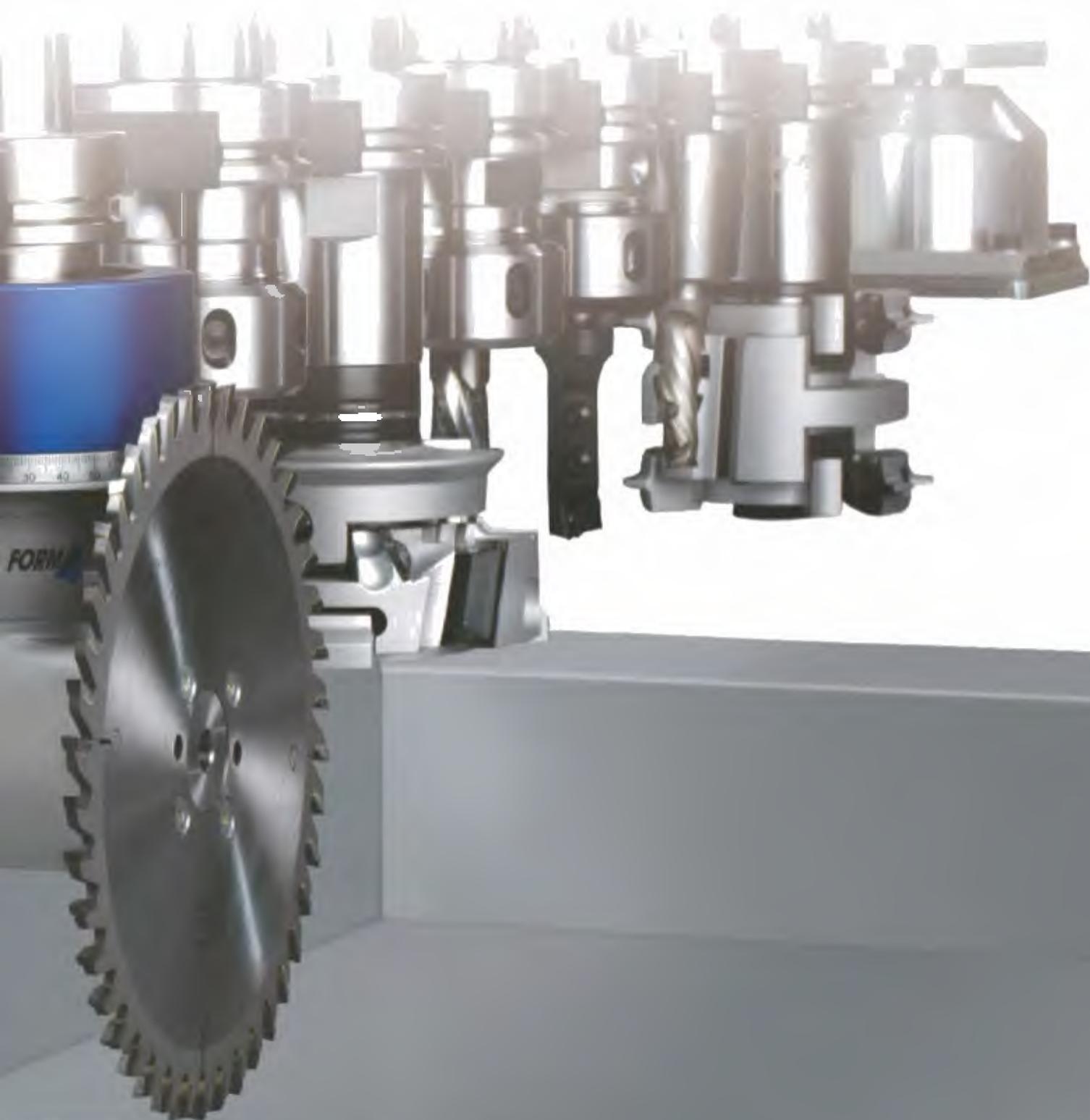

Outstanding productivity: FORMAT-4 in your networked workshop



Data transfer to Ardis

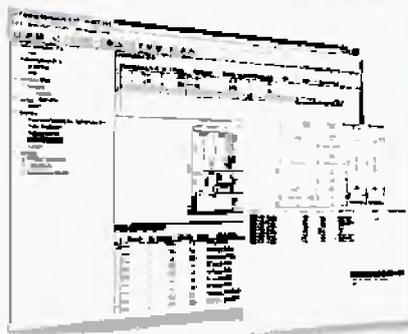

Data transfer to the
panel saw



Planning with "F4Design"

Individual cabinet furniture is created quickly and professionally, simply by inputting a few parameters into the "F4Design" software e.g. during a sales talk. The "F4Design" software automatically generates the data for:

- Presentation
- Construction
- Calculation
- Production
(CNC and edgebanders)

Cutting optimisation with Ardis

Cutting optimisation with Format-4 panel saws has now become even easier. This has been made possible by the integration of the Ardis cutting optimisation software into the Format-4 operating concept. Tool width, edge and direction of grain are all displayed on the clear user interface and enable an efficient processing of perfect cuts from a central position. That saves time, material and ultimately money.

Trimming and formatting

The optimised production information comes from the process preparation via the information network to the panel saw. The working process is displayed on the panel saw TFT screen. The fence and the saw blade position themselves automatically. A label is printed for every workpiece, with barcode information that is required for the following processing steps on the CNC.

The modern workshop: all machines are linked with each other

Take advantage of the potential of increasing the productivity in your workshop even further and combine the "F4Design" and "Wood-Flash" software from the work planning stage with the panel saw, CNC and edgebanders.

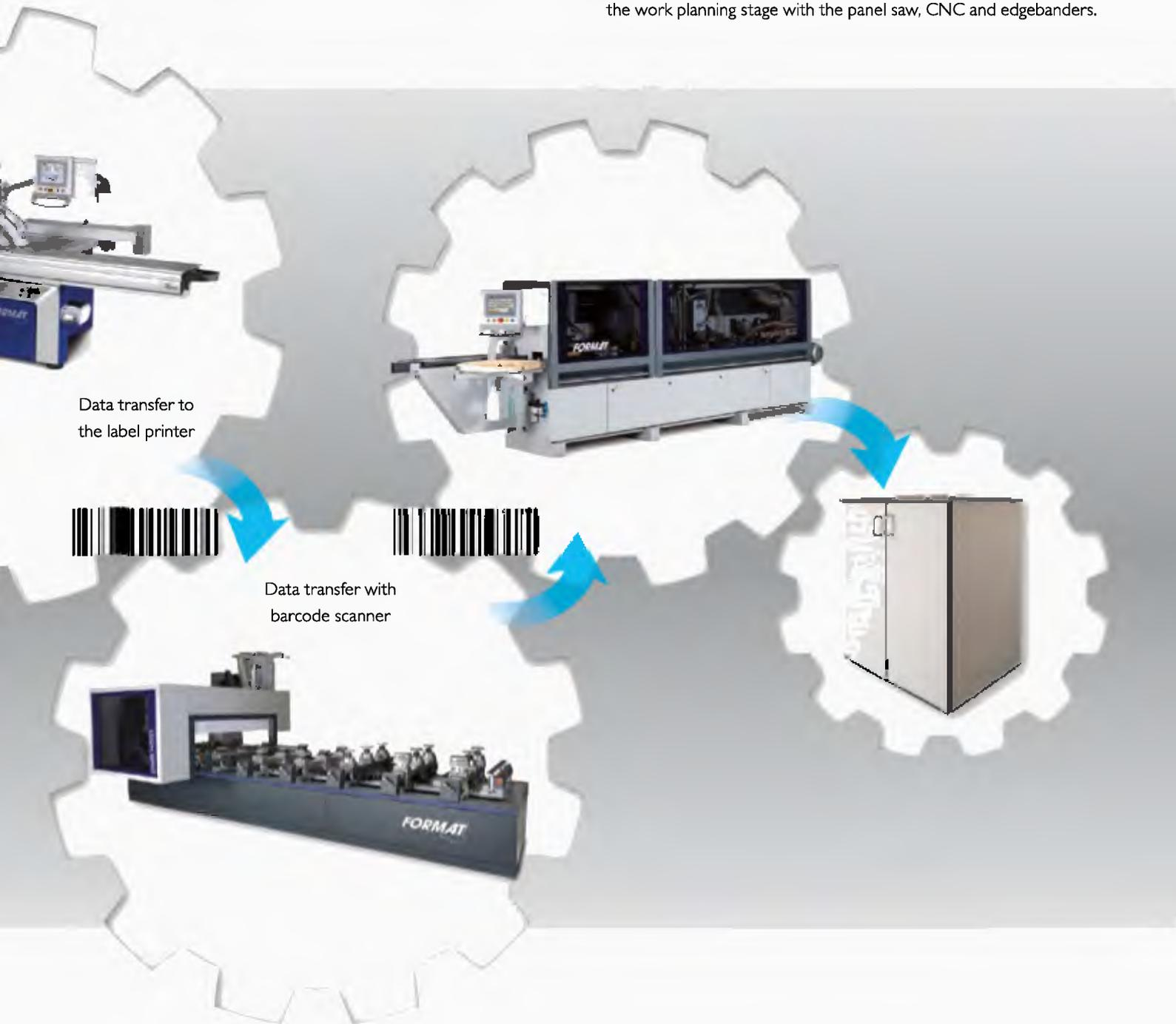

CNC machining

The appropriate program will be loaded once the barcode has been scanned into the CNC. Data import eliminates errors and increases quality assurance; each workpiece machined is a quality product.

Edgebanding

Information such as the type of edging, the thickness and onto which side of the workpiece the edging is to be glued, is shown on the label. Again, saving valuable production time!

The finished piece – sensationally quick

The increase in productivity of Format-4 machines interconnected with a data network, is simply sensational regardless of the complexity. Whatever the workpiece, the use of a Format-4 production system will dramatically reduce the production time.

How big is the step up really?

Craftsmanship



Competitiveness/
Profitability

On the basis of craftsmanship, the CNC triangle expands the current and future competitiveness and profitability of every workshop, in every market, in every field.

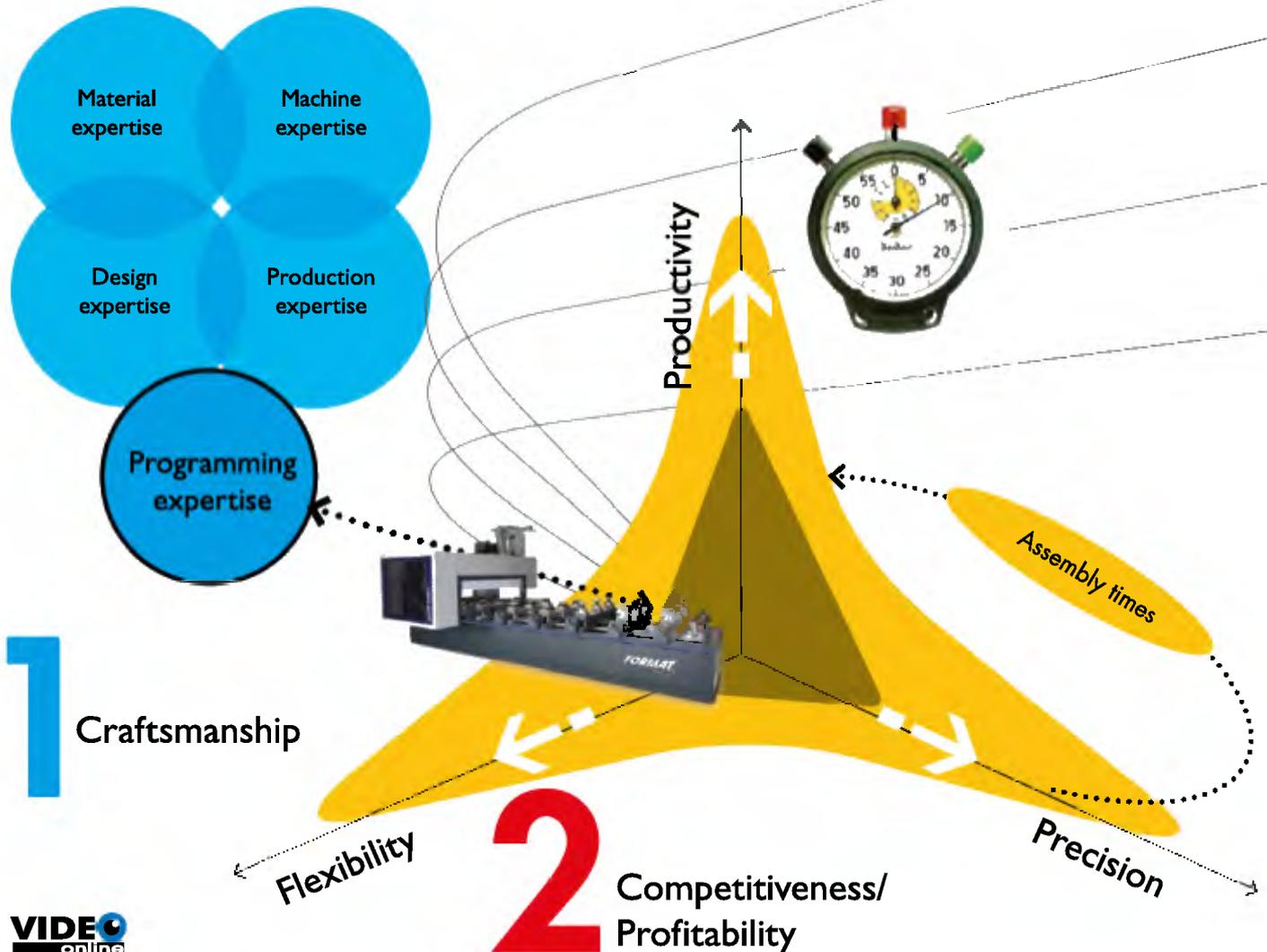

The CNC triangle opens up four directions for every workshop, in order to maximise profitability in a whole range of market scenarios.

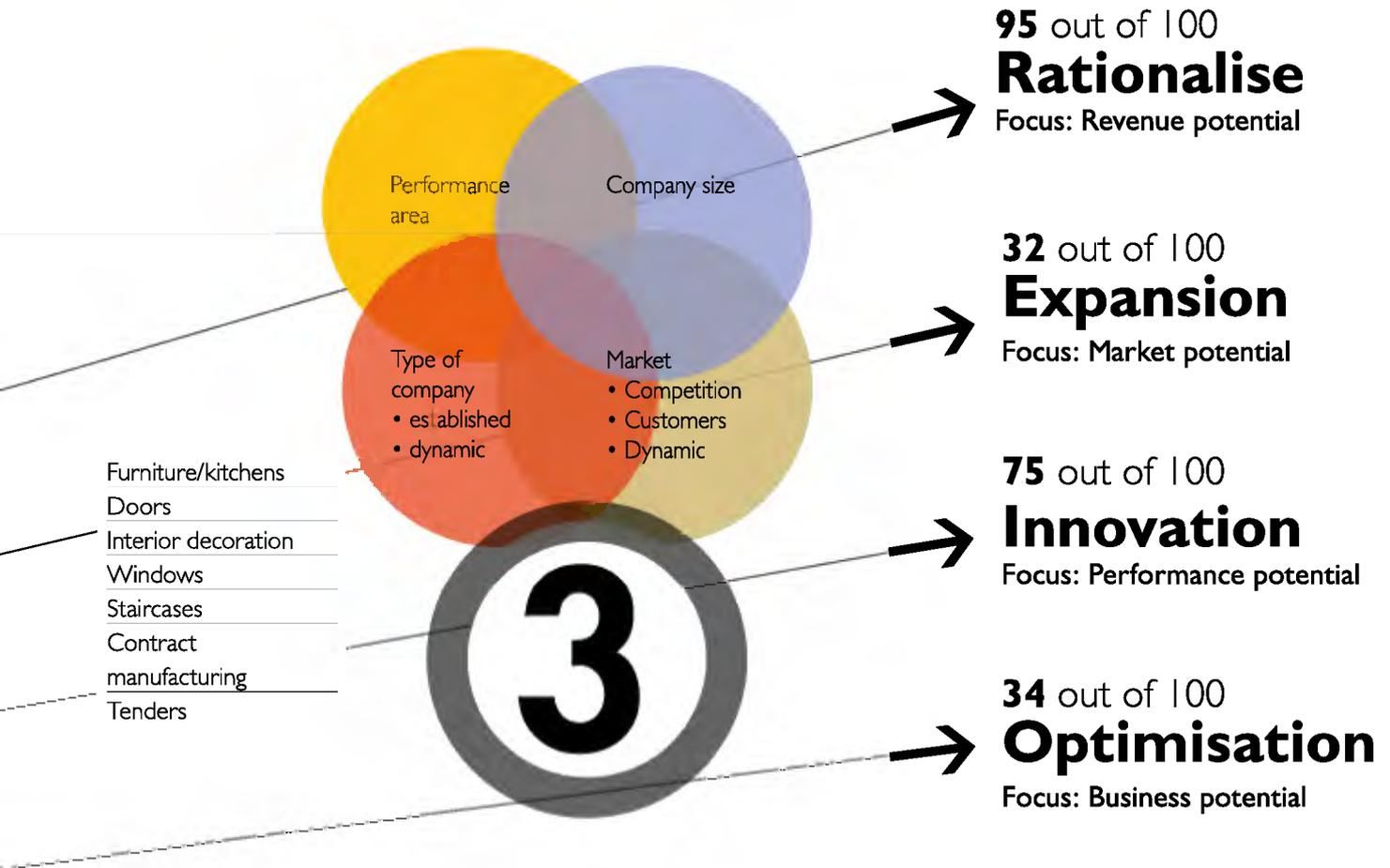

Every carpenter is aware that they require various machines, with different, yet correctly selected tools, to get to the finished product that they want to produce and that these machines need to be adjusted, controlled and operated. It is exactly the same with a CNC machine, but with one difference: The working processes are linked together and summarised (programming) and then carried out on the CNC.

**The "machine expertise" has been the basic requirement of the woodworker for decades.
When will you take the next step?**



With FORMAT-4 CNC technology you can double the capacity and increase your profit with every unit produced!

without CNC
approx. 29 hours

with CNC
in just 14 hours

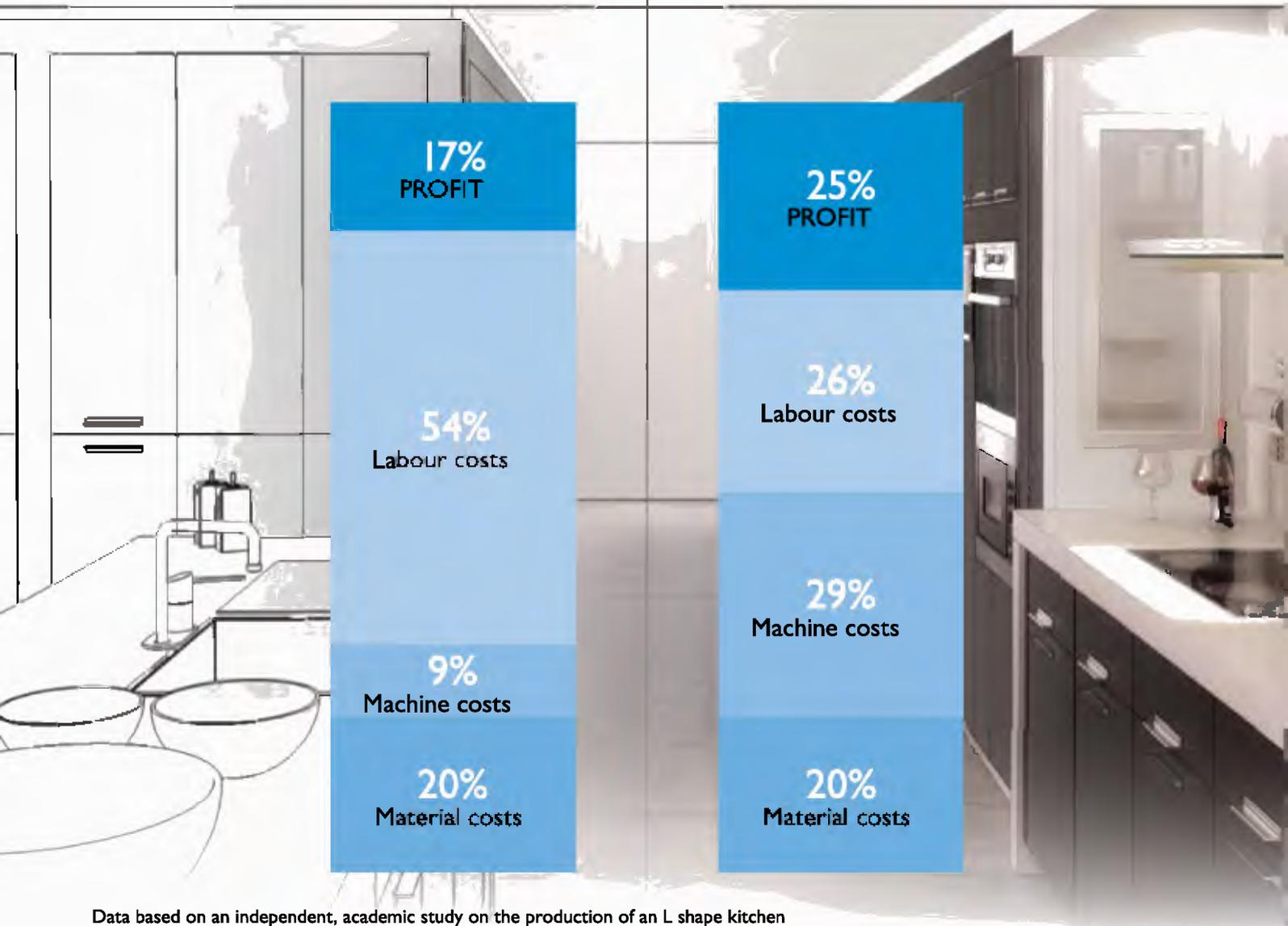

Data based on an independent, academic study on the production of an L shape kitchen with 89 workpieces. The production time includes all of the working processes, from planing to calculation, manufacturing and finally the end product. To see the complete report please contact our team of sales advisors.

Take the first step to more success with profit making CNC technology.
We will help you find a tailor made financing strategy for your desired investment.

6 reasons to go for a CNC! Today many woodworkers are fulfilling their dream of owning a CNC

"CNC is the standard machine of tomorrow!"

What seems complex today is clear tomorrow! Today, CNC machines already play a central role in every workshop. The concept of CNC should not be shied away from, but should be seen as a chance and a new challenge for the future.

1.

The standard machine of tomorrow

Programming within 3 days

Anyone with basic computer knowledge, who can draw their product and knows the required production steps, can develop a solid CNC programming base within 3 days.

2.

Quick and easy to learn programming

From a batch size of 1 and up! The 1 piece series is a reality!

CNC is extremely flexible, individual and customer requirement focused. CNC optimises standard work as well as the highly demanding, design orientated non-standard work.

Once, twice, a hundred times ...

3.

CNC = flexibility = individuality

Founded on craftsmanship!

The basics of programming and an efficient CNC use is craftsmanship. Programming is a new skill, which can be used to increase the profitability and competitiveness.

4.

Craftsmanship and profitability

CNC power is 3 dimensional

CNC expands the competitiveness as well as the profitability of the workshop over three central dimensions. It is a common misconception, CNC should only be seen as a way of increasing the "production speed".

5.

CNC = 3 dimensional

CNC requires big changes

CNC considerably changes a carpenters workshop. CNC removes the limitations that a workshop faces.

6.

CNC is coming

100 of 100 CNC users:
"CNC has become crucial to my work"

"Easier to program than expected" 78 out of 100 CNC users

87 of 100 CNC users:
"... my CNC expectations were exceeded."

Can one compete against CNC workshops without a CNC?
81 of 100 CNC users say: "no!"



CNC machine range overview

profit H500



profit H350

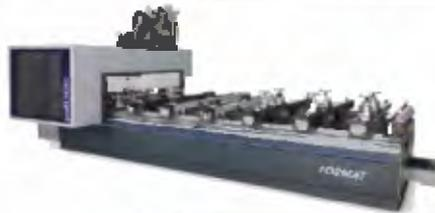

profit H300



profit H200



profit H10

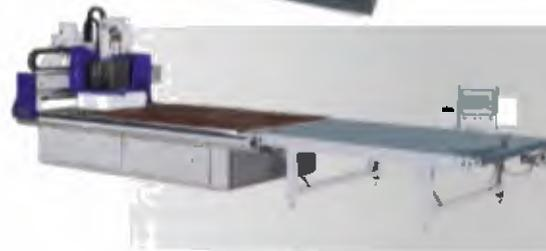

profit H08



c-express 920
classic



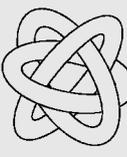
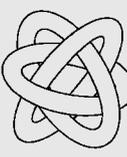
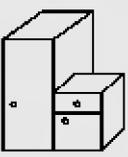
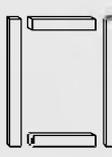
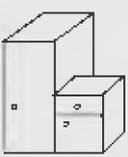
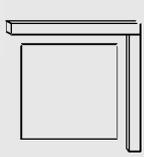
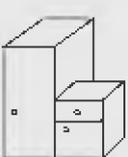
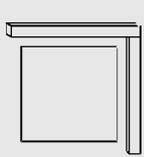
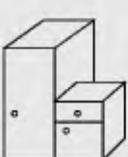

Cabinets	Doors	Staircases	Special designs	Frames	Panel processing of various materials	5 axes applications
						
						
						
						
						
						
						

c-express 920 classic

FORMAT

Complete processing
of cabinets in
only 3.4 m²

The Format-4 c-express 920 classic CNC drilling and milling machine executes all repeat drilling and simple milling work quickly, economically and precisely. Developed specially for small workshops, the c-express 920 classic offers a sensational price-performance ratio. The uncompromising new release from the Felder Group is profit making CNC productivity in a nutshell. Repeat drilling programs can be recalled and reused at the touch of a button, workpiece after workpiece, order after order. CNC controlled cabinet manufacturing is now profitable for every workshop, regardless of how much free space is available.



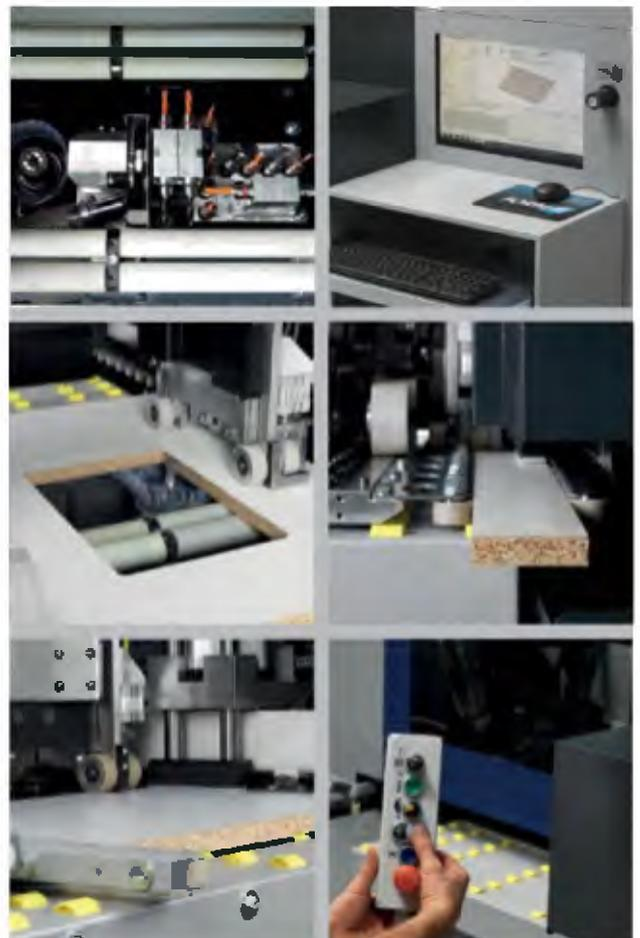

The CNC drilling
and milling head

Simplest
programming
and operation

Milling of cutouts,
pockets, grooves
and rebates

Workpiece width
from 70-180 mm

Workpiece transport

Freely positionable
hand terminal

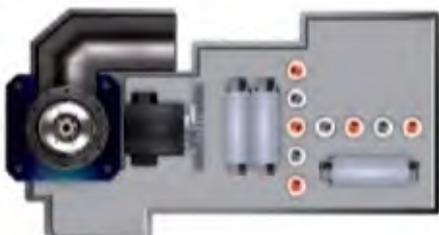
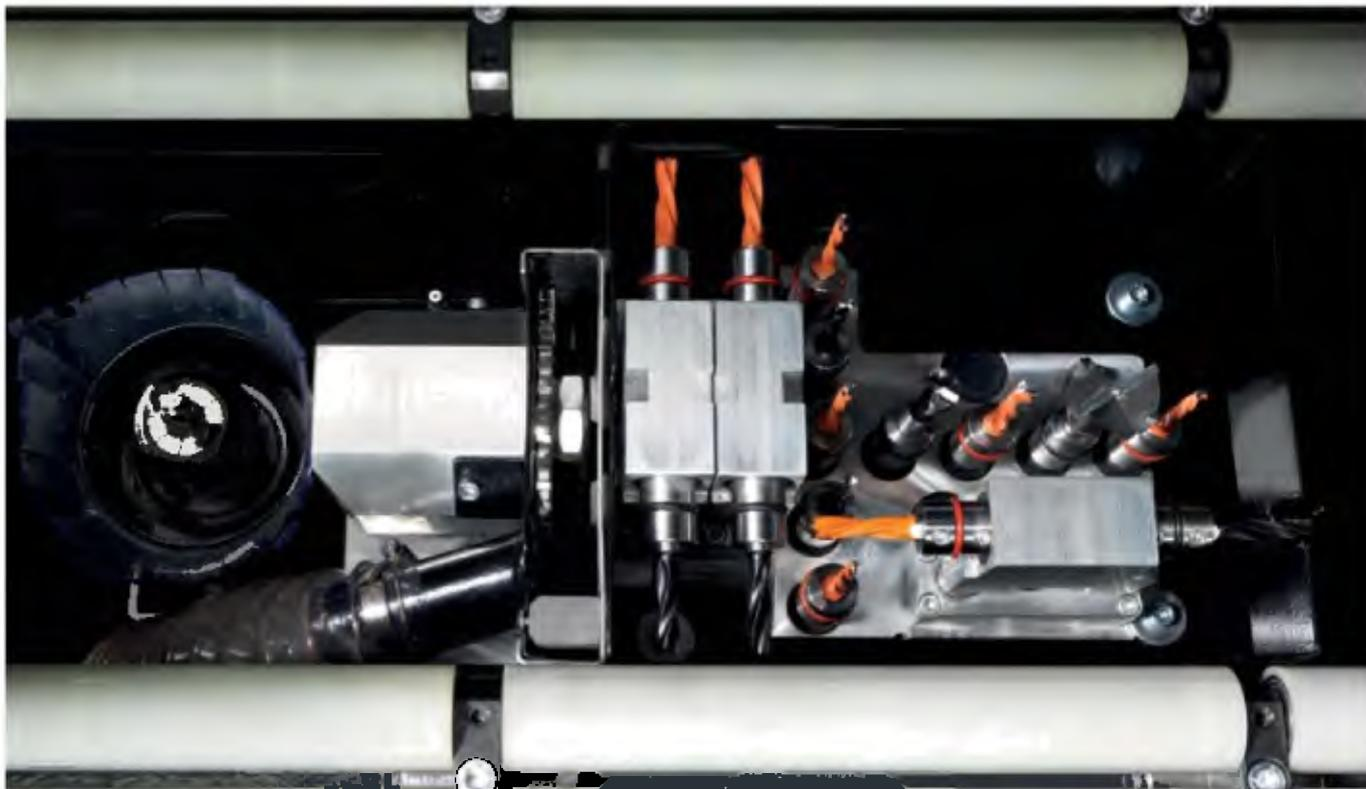

The CNC drilling and milling head

The c-express 920 classic is equipped with a DH15 6H 1S drilling head as standard. The 15 spindles can be individually equipped as required for the processes to be carried out. The grooving saw is equipped with a scoring function and enables chip free cutting of rear walls or constructions joints.

- 9 vertical spindles
- 6 horizontal spindles
- 1 grooving saw blade in the X direction

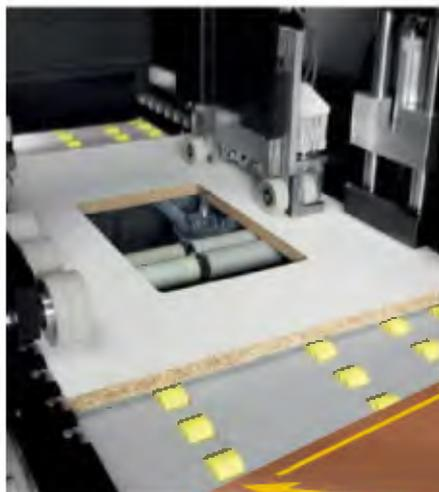

Milling spindle

One of the equipment options on the machine is the milling aggregate. The tool is clamped using an ER32 chuck. Changing of the tool is carried out manually. This milling spindle is used for the routing of cutouts, pockets, grooves and rebates in the workpiece.



Milling

The milling unit can be used for 3 sided formatting cuts as well as for making cutouts in panels, as long as the workpiece keeps its right angled shape along the outer edge.



Workpiece transport

The horizontally designed transport system ensures the smooth transport and accurate positioning of workpieces of up to 30 kg in weight, allowing them to be processed from below by the aggregates. This design of the clamp transport system allows the workpieces to be fed in horizontally. This method of workpiece processing prevents the workpieces being moved or burnt by the tooling. The fence positioned on the side allows the width of the workpiece to be set at any value up to 920 mm. The workpiece is then supported and guided from both sides guaranteeing a highly precise result.

Workpiece widths 70-180 mm

An extra attachment for narrower workpieces enables the exact processing of workpieces of between 70–180 mm in width.





Roller pressure device

When processing very wide or thin workpieces the pressure device guarantees an exact processing depth.

Measuring technique

The use of the most modern measuring technology guarantees precise measuring of the dimensions. A laser and encoder measuring system are used to measure the exact length of the workpiece. This is of particular importance when it comes to construction connections for cabinets, ensuring that there is no overhang between the panels.



Additional vertical clamp

ideal for the improved processing of longer workpieces.

Simple programming and operation

The controls of the Format-4 have been specially developed for woodworking machines for drilling, milling and sawing. Operation of the machine is carried out using a graphical user interface (self-explanatory diagram display). The programming software "Wood-Flash" makes it very simple and quick to program workpieces. All operations to be carried out on the workpiece are clearly displayed on the 19" LCD colour display. As an option it is possible to link the machine with the cabinet programming software "Flash 3D", that guarantees an even more rational processing of your customer orders.



Pressure setting of the clamps

In order to achieve an optimal result even when processing sensitive surfaces. Maximum adjustable pressure up to 100 kg.



Freely positionable hand terminal

The working process is simplified as the hand terminal can be positioned as required. It is always there, where it is needed.



Unload the workpiece from the rear

This function allows the operator to program the machine to feed the workpiece out to the rear when finished. This system allows the c-express 920 classic to be used in a production line. Selecting the unloading direction is easy to do, using a selection switch.

Space requirement

Scale
1:50

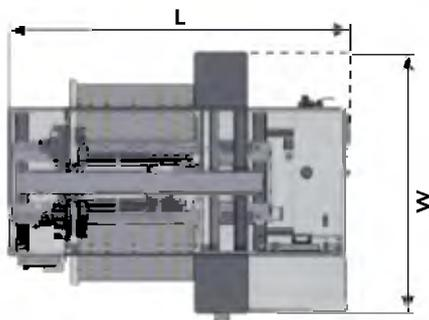

Symbolic image c-express 920 classic

Working areas	max.	Min.
X	3,000 mm	280 mm
Y	920 mm	70 mm
Z (Clamping range)	50 mm	10 mm

	c-express 920 classic
Height [H]	1,950 mm
Length [L]	2,100 mm
Width [W]	1,605 mm
Weight (depending on equipment, without packaging)	850 kg

Dimensions given can vary if special options are selected

profit H300
profit H200

FORMAT[®]



Convincing in all areas

Affordable CNC technology is becoming increasingly important in the universal workshop in particular. Regardless of whether a series of regular standard products or individually designed one-offs are to be made, the universal Format-4 profit H200 and profit H300 CNC machining centres produce finished workpieces with maximum efficiency and are a real profit earner even from day one.

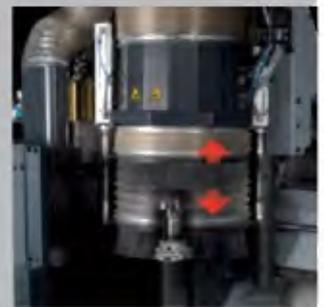

Hose free dual circuit vacuum pod system

Automatic central lubrication system

Visual display of the status using changing coloured lights

Unlimited processing possibilities

The solid gantry design including gantry drive

Controlled extraction hood



profit H200

Working area



Hose-free FORMAT-4 2 circuit system with vacuum pod height of 100 mm

The dual circuit vacuum console table with manual vacuum pod positioning prevents any unintentional movement of the clamps whilst loading the workpiece. Various different Format-4 vacuum pods can be used to hold in place all conceivable work-piece shapes and sizes quickly and securely.



Position display of the consoles and vacuum pods

The workpiece, consoles and vacuum pods are all displayed in the CNC board at the same time. This guarantees, that the workpiece is securely positioned and that there can be no collision between the tool and vacuum pod. The exact position of the vacuum pods on the consoles is shown using a laser.

Linear positioning laser

Line laser for virtual 0-position in the Y direction for precise positioning of segmental arch frames.



Rows of stops

Workpiece cylinder stops at the "double zero point" (second fence row)

In addition to the workpiece cylinder stops at the "standard zero point", a second row of stops is available on each console as an option, to be able to process narrow workpieces in the front working field.



Frame processing

Continuous fence in the Y direction for an exact positioning of frame components.



Moving gantry

The gantry is driven on both sides along the X-axis, running on an angled and cambered tooth rail. (H300)



Loading supports

Loading supports assist in the simple loading and unloading of large or heavy workpieces. A major advantage is that they enable you to operate the machining centre alone.



Reinforced loading supports

Optional reinforced supports for particularly heavy workpieces.



Template milling

For template milling there is a separate connection available. Using templates makes it possible to fix complex components in place, that could otherwise not be processed using vacuum pods.



Console activation

Specially designed for use with compressed air controlled frame clamp systems, this function offers new possibilities and enormous clamping strength when it comes to the processing of solid wood. The ability to be able to deactivate the consoles individually makes it possible to remove offcuts without having to release the vacuum that is holding the workpiece in place. This ensures that the workpiece stays in exactly the right position for the next working process (inner profiles etc.).



Workpiece stop for veneered panels

Additional to the workpiece fence cylinders there are also separate fences available for the processing of veneered surfaces with a projecting edge or laminated panels.



Field configuration of consoles, clamping options

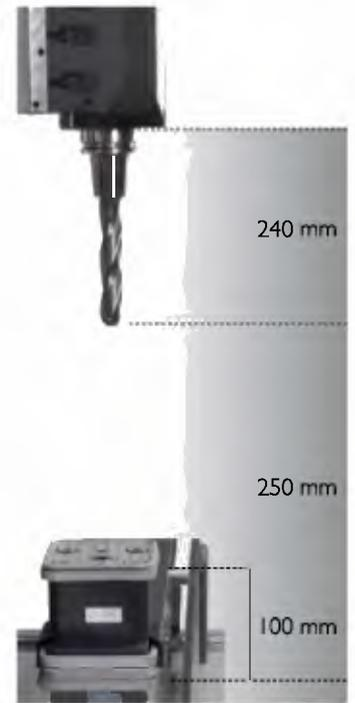
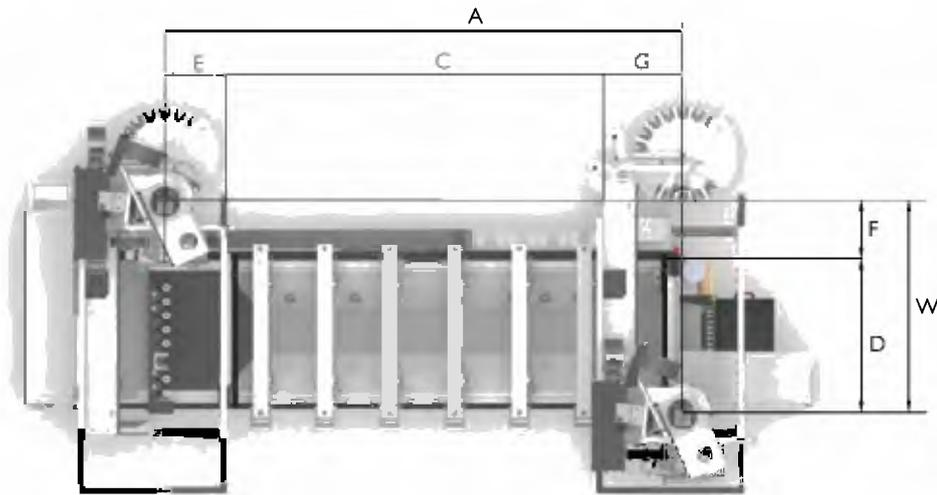

Working areas, traverse distances

profit H200 13.33	profit H300 16.33	profit H300 16.59
A 4,000 mm	A 4,000 mm	A 6,000 mm
B 1,670 mm	B 1,970 mm	B 1,970 mm
C 3,300 mm	C 3,300 mm	C 5,300 mm
D 1,280 mm	D 1,580 mm	D 1,580 mm
E 540 mm	E 540 mm	E 540 mm
F 390 mm	F 390 mm	F 390 mm
G 160 mm	G 160 mm	G 160 mm

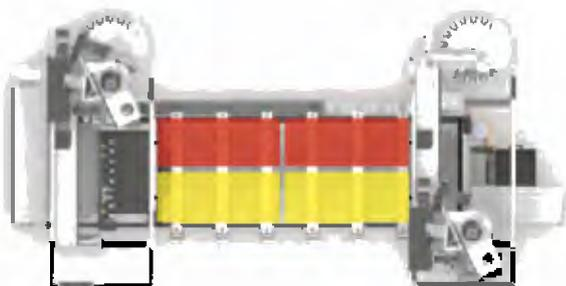

2 working fields in the X direction for pendulum operation: With front and rear fences

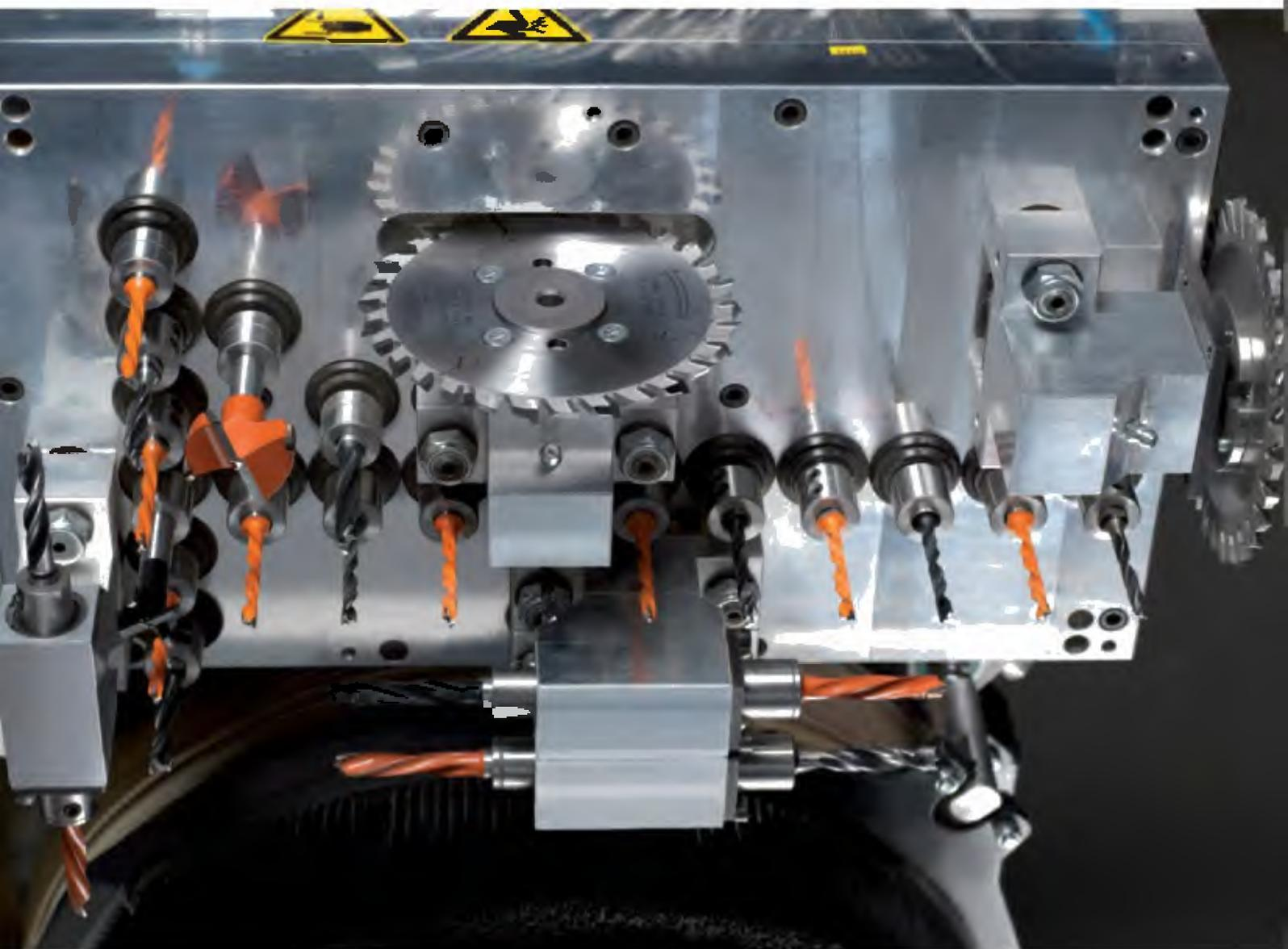

Drilling head

The drilling head with 24 spindles

- 18 vertical drilling spindles, 32 mm distance between spindles: Each can be used individually
- 6 horizontal drill spindles, spaced at 32 mm:
 - 4 in the X and 2 in the Y axis, each can be used individually
- Integrated grooving saw units positioned in both the X-axis and Y-axis direction
- Inverter driven motor up to 7,500 rpm

Highlight

The complete working field can be covered by the drilling head for vertical and horizontal drilling.

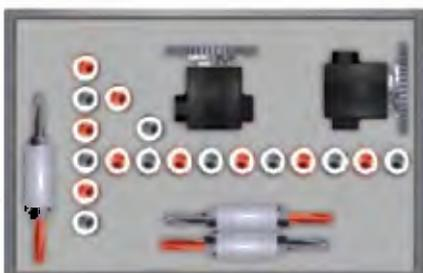

DH 24 6H 2S



Configuration option DH 16 4H 2S

Spindle

With a motor power of 12 and 15 kW and up to 24,000 rpm, the main milling motor is controlled using an inverter and is attached directly to the support module of the drilling head in the Z axis. Dual linear guides guarantee highly precise vertical guiding. The main milling motor is positioned using ground ball screws. The HSK F63 tool clamping is done automatically. The clamping of the tool is checked using sensors, which then confirm that it is safe to start the operation. The tool holder is cleaned pneumatically. The C-axis is optionally available as the fourth axis and is interpolating (360°) with a compressed air interface for the units.



Chip deflector

A chip deflector mounted to the spindle controlled by the C-axis enables the unrestricted use of existing tools. When processing workpiece edges the dust and chips are directed towards the extraction canal.



Chip conveyor

Chip conveyor for waste pieces and residual chips and dust: For the removal of offcuts and chips from the machine chassis (right hand side). At the end of the conveyor belt they are separated using a separating slide and then extracted. The offcuts are collected in a container.



Controlled extraction hood

The extraction hood positions itself fully automatically to one of 3 positions in relation to the workpiece height which significantly reduces the dust and noise emissions.



Extraction connection

With the automatic control of the extraction connection, the full extraction capacity is moved between the drilling head and main spindle, depending on what is being used at the time.



Compressed air nozzle/spraying unit

Mounted onto the main spindle to optimise milling work.

Tooling positions and space requirements

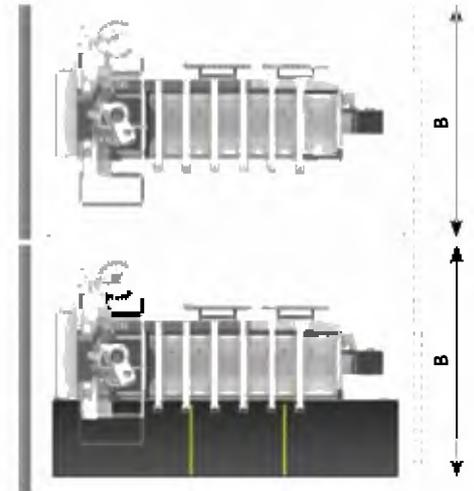
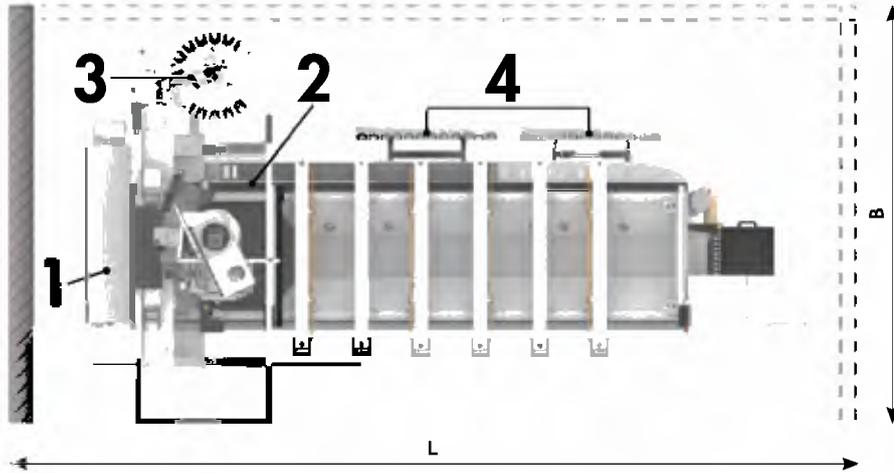

Symbolic image

	profit H200 13.33*	profit H200 13.33	profit H300 16.33	profit H300 16.53
Height [H]	2,300 mm	2,300 mm	2,300 mm	2,300 mm
Length [L] with pressure guard	-	6,588 mm	6,588mm	8,573 mm
Width [W] with pressure guard	-	3,493 mm	3,642 mm	3,642 mm
Length [L] with light barrier	5,838 mm	6,323 mm	6,338 mm	8,323 mm
Width [W] with light barrier	4,290 mm	4,290 mm	4,440 mm	4,440 mm
Length [L] with safety mats	-	6,323 mm	6,338 mm	8,323 mm
Width [W] with safety mats	-	4,235 mm	4,385 mm	4,385 mm
Weight (depending on equipment, without packaging)	3,650 kg	3,650 kg	3,900 kg	4,300 kg

*Special equipment



1 12 position linear tool changer

On the left hand side of the machine including one pick up place for aggregates.



3 18-position rotary tool changer mounted to the outrigger

The rotary tool changer with 18 tool positions is mounted to the back of the gantry and moves together with the gantry along the X-axis. The 18-position rotating tool changer, keeps tool changing times to the bare minimum.



2 4 position linear tool changer moving in the X-axis direction

Tool changer for 4 tools or aggregates, mounted to the gantry. Ensures quick tool changes even when working in pendulum operation.

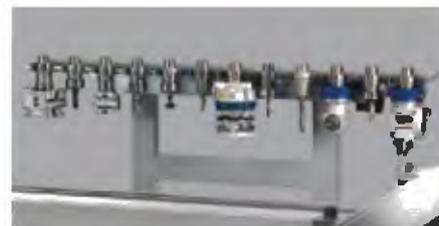

4 12 position linear tool changer mounted to the machine chassis

The tool changer with 12 tooling positions improves productivity and creates more space for additional tools on the machine.

Application examples



Steps/staircase production



Solid wood manufacturing

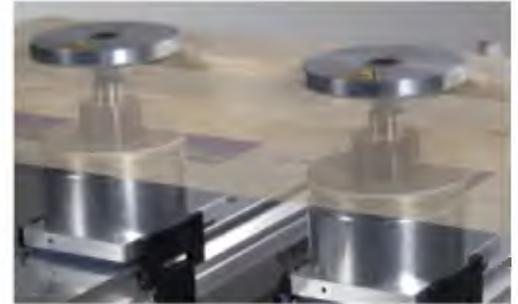

Frame processing



Template milling



Cabinet production



Working with veneer fences

Workpiece examples

Unlimited processing possibilities,
for a variety of shapes and uses

The high flexibility and quick operational readiness of the profit H200 and H300 CNC machines are supported by Format-4 programming software. They ensure, that every individual workpiece, whether easy or difficult to produce, can be produced quickly, economically and profitably. The Format-4 programming software with numerous functions is particularly efficient, multifunctional and self-explanatory.

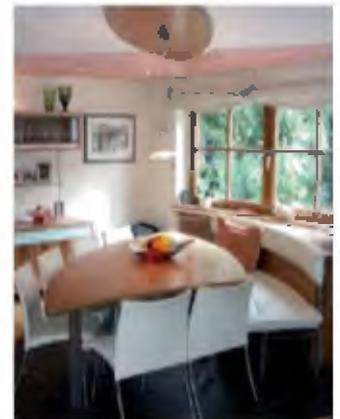

Various materials:
Plastics, Alucobond, mineralised
substances, packing material

The variable speed control (max. 24,000 rpm) and the variable feed rate in combination with the right tool, guarantee outstanding results, even when processing plastic. Regardless of whether it is thin workpieces on a template or heavy workpieces, Format-4 covers everything.



profit H500
profit H350

FORMAT[®]

One machine,
five axes, limitless
creativity



It is universal workshops in particular, where the individual processing of various materials is becoming increasingly important. The most up-to-date 5 axes CNC technology guarantees limitless creativity, and at the same time reduces the initial investment cost and subsequent costs for special aggregates and tools. Individual workpiece design and fully automated production with minimal investment – with the profit H500, Format-4 makes the future of component, production affordable.

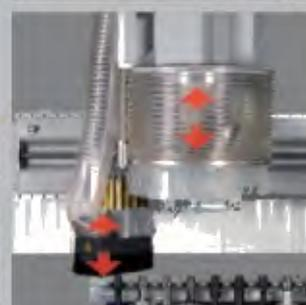

Hose free dual circuit vacuum pod system

5 axes - no restrictions

Visual display of the status using changing coloured lights

Unlimited processing possibilities

Automatic consoles and vacuum positioning

Aggregate carrier with two Z-axes



profit H350

Working area

Hose-free FORMAT-4 dual circuit system with vacuum pod height of 100 mm

The dual circuit vacuum console table with manual pod positioning prevents any unintentional movement of the clamps whilst loading the workpiece. Various different Format-4 vacuum pods can be used to hold in place all conceivable workpiece shapes and sizes quickly and securely.



Positioning display of consoles and vacuum pods

The workpiece, consoles and vacuum pods are all displayed in the CNC board at the same time. This guarantees, that the workpiece is securely positioned and that there can be no collision between the tool and vacuum pod. The exact position of the vacuum pods on the consoles is shown accurately using a laser.



Frame processing

Continuous fence in the Y direction for an exact positioning of frame components.

Rows of stops

Workpiece cylinder stops at the "double zero point" (second fence row)

In addition to the workpiece cylinder stops at the "standard zero point", a second row of stops is available on each panel support as an option, to be able to process narrow workpieces on the front working field.



The "s-motion" consoles

The fully automatic "s-motion" consoles enable you to completely process door and window components extremely quickly and with first class quality.

Quick, hose-free change from frame to panel processing without any additional changeover work required.

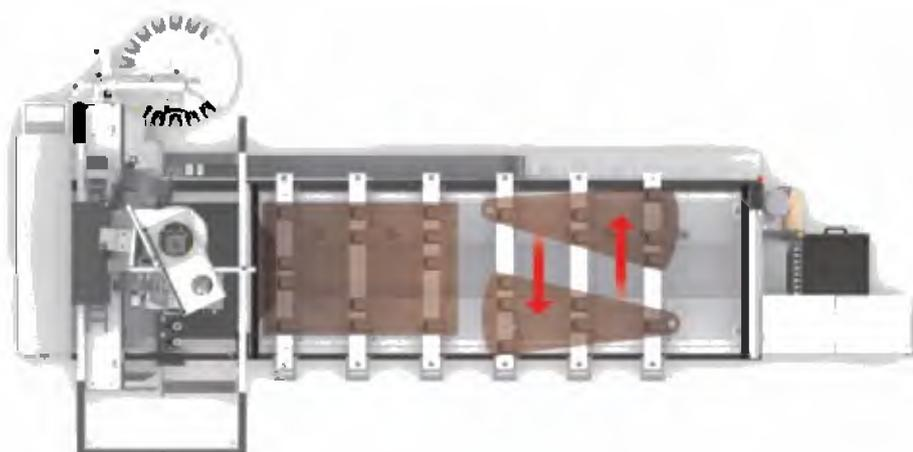

"s-motion" table for the automatic positioning of the vacuum pods and frame clamps in less than 30 seconds. Workpieces can be moved in both the X and Y direction, so that as an example once a step has been milled out, the rest of the working processes can continue straight away. As the workpiece is being processed on the right hand side of the machine, the table on the left will already be automatically preparing everything for the next stage of production. The productive "s-motion" table guarantees real time savings when working in pendulum operation.



Linear positioning laser

Linear laser for virtual 0-position in the Y direction for precise positioning of segmental arch frames.



Dual line laser

When positioning workpieces on split working fields, the optionally available double line laser which is positioned on the middle of the working field in X can be of assistance.



Loading supports

Loading supports assist in the simple loading and unloading of large or heavy workpieces. A major advantage is that they enable you to operate the machining centre alone.



2 level loading supports for frame processing when working alone

Loading supports at level 2: Glued frames are brought into position using the frame clamps for the outer profiling. Loading supports then drop to level 1, the frame clamps then hold the glued frame in place.

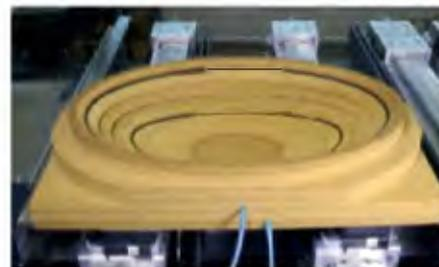

Template milling

For template moulding work there is a Ø-12 connection available in each working field. Using templates makes it possible to fix complex components in place, that cannot be processed using vacuum pods.



Workpiece stop for veneered panels

Additional to the workpiece fence cylinders there are also separate fences available for the processing of veneered surfaces with a projecting edge or laminated panels.



Console activation

Specially designed for use with compressed air controlled frame clamp systems, this function offers new possibilities and enormous clamping strength when it comes to the processing of solid wood. The ability to be able to deactivate the consoles individually makes it possible to remove offcuts without having to release the vacuum that is holding the workpiece. This ensures that the workpiece stays in exactly the right position for the next working process (inner profiles etc.).

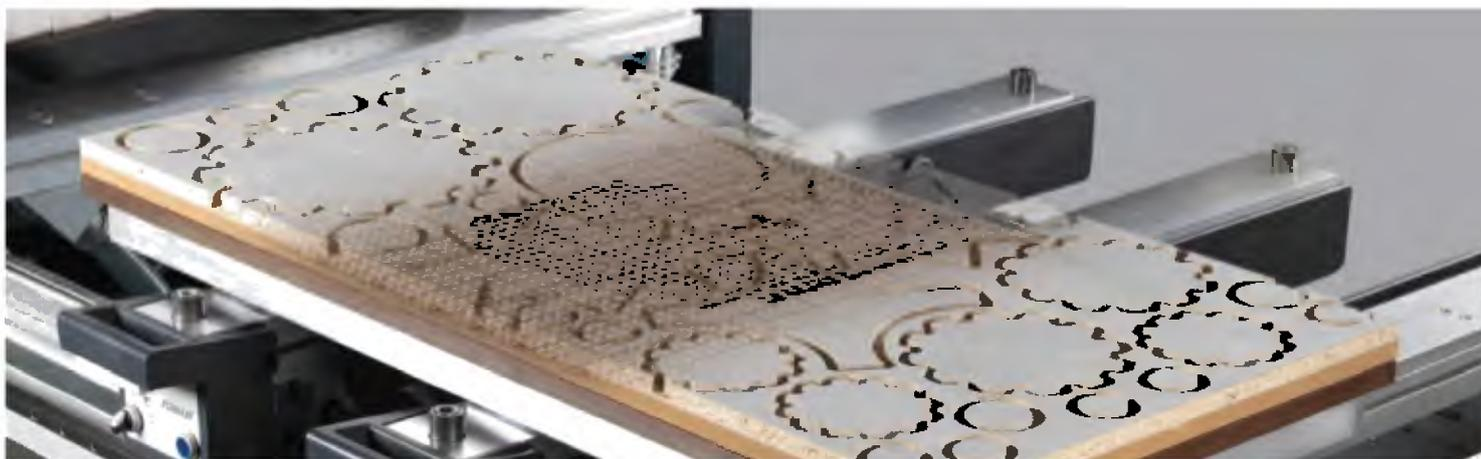

Perfect nesting with the FORMAT-4 matrix table

The nesting table with optimal matrix geometry can be placed directly on the consoles and enables the full panel support of workpieces of any size and design, guaranteeing exact positioning.

Console field configuration, clamping options

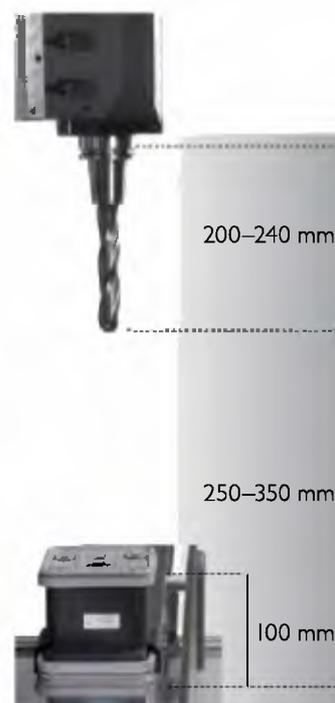
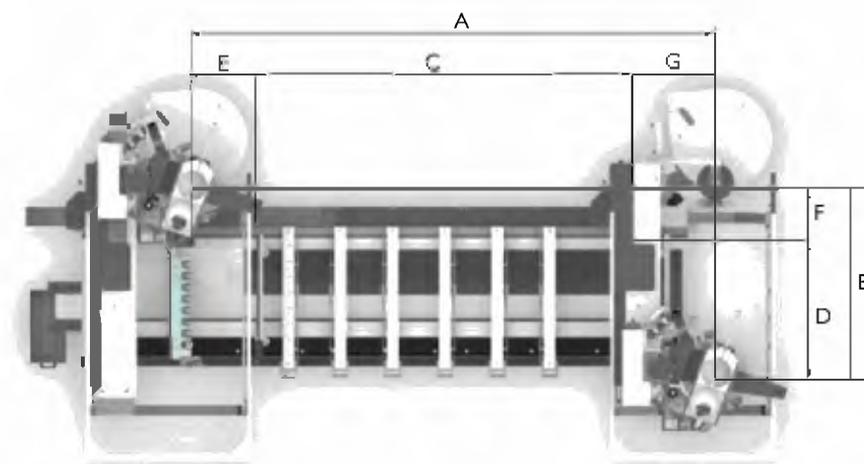

Working areas, traverse distances

<i>profit H350</i> 16.30	<i>profit H350</i> 16.50	<i>profit H500</i> 16.38	<i>profit H500</i> 16.58
A 4,000 mm	A 6,010 mm	A 4,930 mm	A 6,730 mm
B 1,970 mm	B 1,970 mm	B 1,925 mm	B 1,925 mm
C 3,000 mm	C 5,000 mm	C 3,740 mm	C 5,540 mm
D 1,550 mm	D 1,550 mm	D 1,570 mm	D 1,570 mm
E 540 mm	E 540 mm	E 690 mm	E 690 mm
F 420 mm	F 420 mm	F 420 mm	F 420 mm
G 460 mm	G 460 mm	G 500 mm	G 500 mm

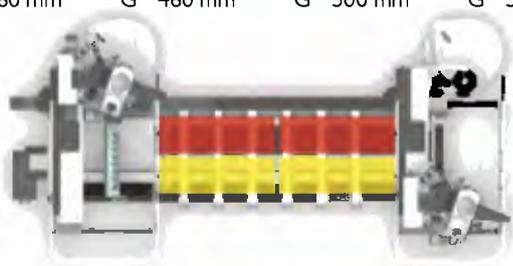

2 working fields in the X direction for pendulum operation; with front and rear fences

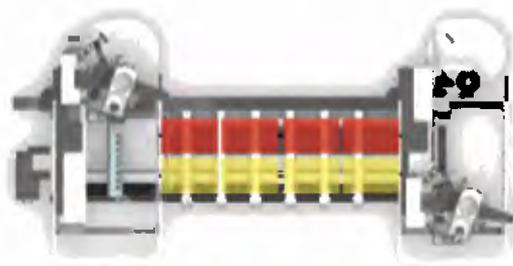

profit H500 16.58: 4 working fields in the X direction with a central row in X for pendulum operation using a laser; with front and rear fences

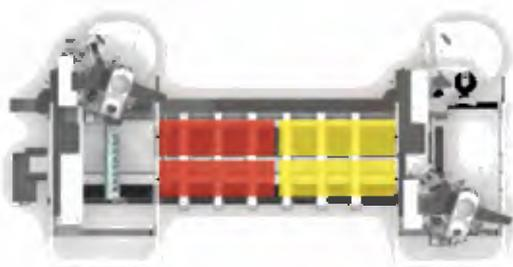

2 working areas in X, 2 in Y for pendulum operation

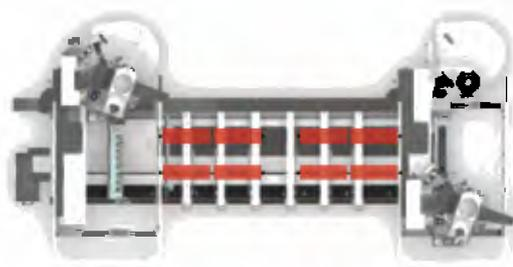

profit H500 16.58: One working area for 8 workpieces for frame production



Limitless machining diversity with the FORMAT-4 drilling group and the powerful 5-axes spindle

Drilling head

The drilling head with 18 drilling spindles

- 12 vertical drilling spindles, 32 mm distance between spindles: each can be used individually
- 6 horizontal drill spindles, spaced at 32 mm: 4 in the X and 2 in the Y axis, each can be used individually
- Integrated slot cutter in the X-axis
- Inverter driven motor up to 7,500 rpm

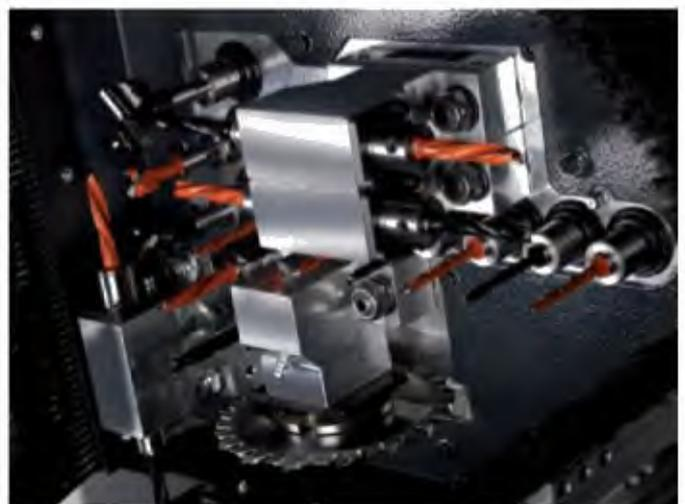

DH 18 6H IS

Highlight

The complete working field can be covered by the drilling head for vertical and horizontal drilling.



FORMAT

The main spindle: 5 axes - no restrictions

The high performance 5 axes spindle with 12 or optionally 15 kW motor guarantees excellent results when milling, drilling and cutting at every angle. The special liquid cooling and high quality ceramic bearings ensure durable precision and processing smoothness of every material. An inverter regulates the speed up to 24,000 rpm.

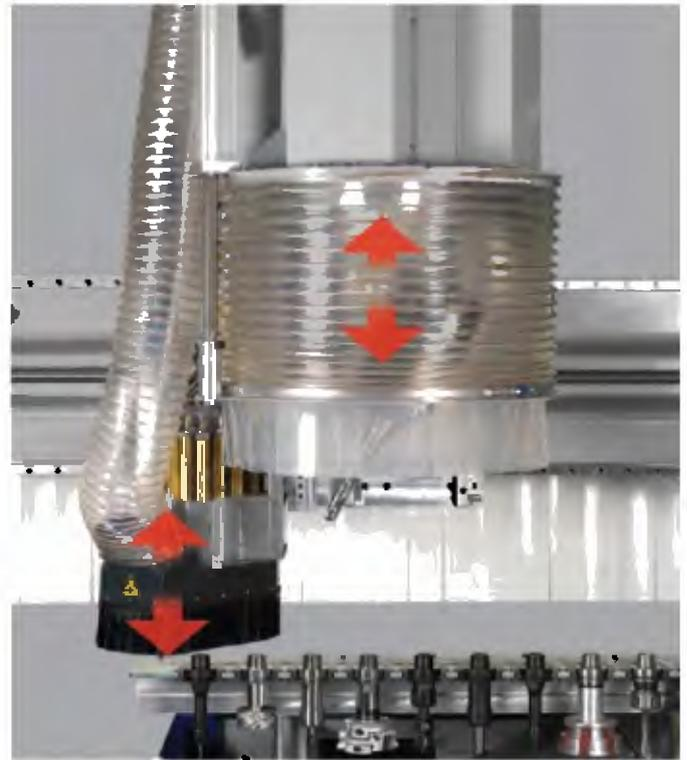
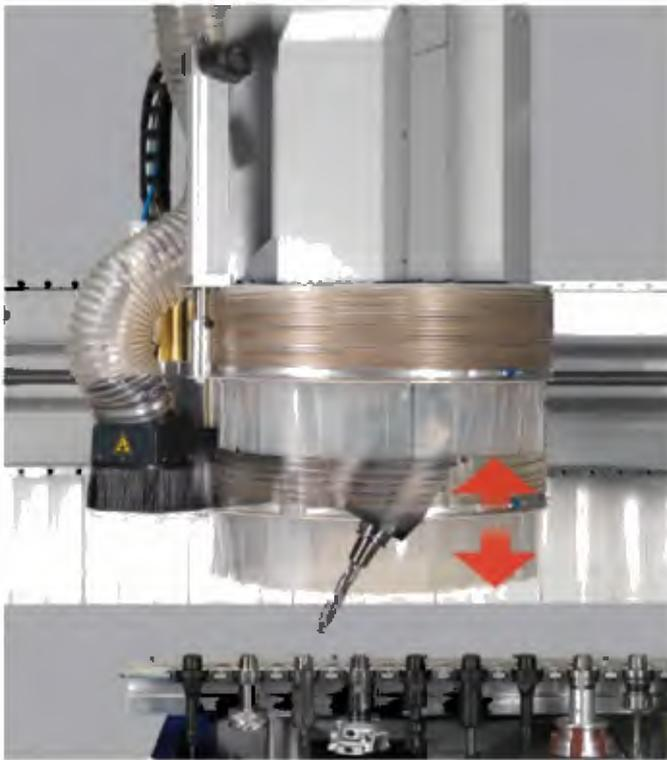

Variable position controlled extraction hood

The extraction hood adjusts itself fully automatically to the workpiece height which significantly reduces the dust and noise emissions.

2 CNC controlled Z axes

The aggregate carrier with two Z axes enables the quick, varying use of drilling head and main spindle. The travel distance of the Z axis is 500 mm, ensuring that long tools can be used even on high workpieces.

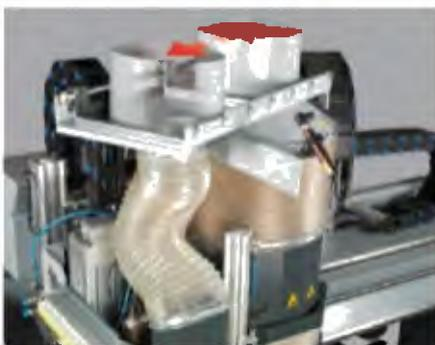

Controlled extraction connections

With the automatic control of the extraction connection, the full extraction capacity is moved between the drilling head and main spindle, depending on what is being used at the time. Efficient extraction results guaranteed.



Chip conveyor

Chip conveyor for waste pieces and residual chips and dust: For the removal of offcuts and chips from the machine chassis (right hand side). At the end of the conveyor belt they are separated using a separating slide and then extracted. The offcuts are collected in a container.



Chip deflector

A chip deflector mounted to the spindle controlled by the C-axis enables the unrestricted use of existing tools. When processing workpiece edges the dust and chips are directed towards the extraction canal.

Tooling positions and space requirements

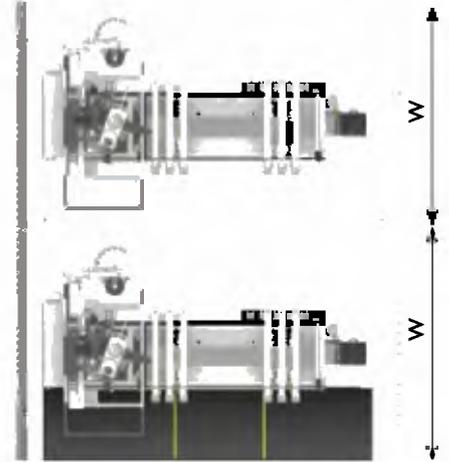
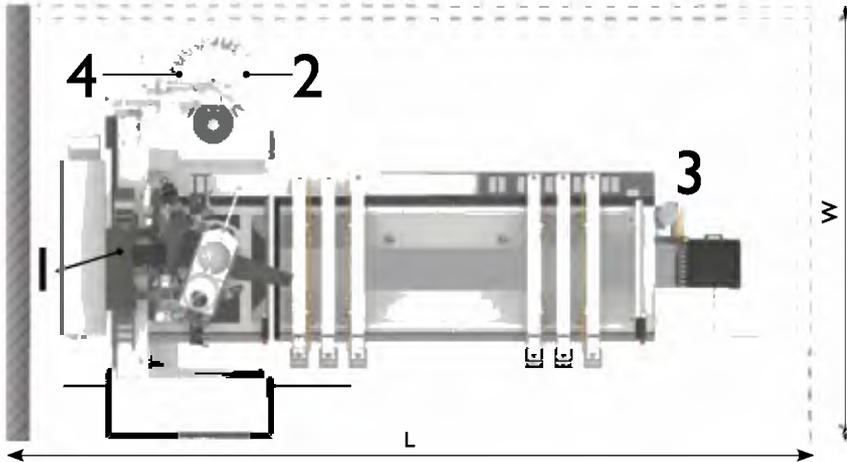

Symbolic image

	profit H350 16.30	profit H350 16.50	profit H500 16.38	profit H500 16.56
Height [H]	2,300 mm	2,300 mm	2,640 mm	2,640 mm
Length [L] with pressure guard	6,840 mm	8,840 mm	8,360 mm	10,098 mm
Width [W] with pressure guard	3,671 mm	3,671 mm	4,850 mm	4,850 mm
Length [L] with light barrier	6,590 mm	8,590 mm	8,110 mm	
Width [W] with light barrier	4,475 mm	4,475 mm	5,075 mm	
Length [L] with safety mats	6,590 mm	8,590 mm	8,110 mm	9,848 mm
Width [W] with safety mats	4,415 mm	4,416 mm	4,975 mm	4,943 mm
Weight (depending on equipment, without packaging)	4,100 kg	4,300 kg	4,500 kg	5,000 kg



- 1 Linear changer, mounted to the machine chassis**
The tool changer with 10/12 tooling positions improves productivity and creates more space for additional tools on the machine.



- 2 Rotary tool changer, mounted to the outrigger**
The rotary tool changer with 18/24 tool positions is mounted at the back of the outrigger and moves with the outrigger along the X-axis. The 18/24 position rotating tool changer, keeps tooling changing times to the bare minimum. This makes the Format-4 even more productive!



- 3 An additional 24 position rotary tool changer (H500)**
Positioned to the side of the machine chassis, it offers an additional 24 tooling positions for even quicker production cycles.



- 4 Saw blade changer**
Travels with the outrigger for saw blades with a max. Ø 350 mm

Application examples

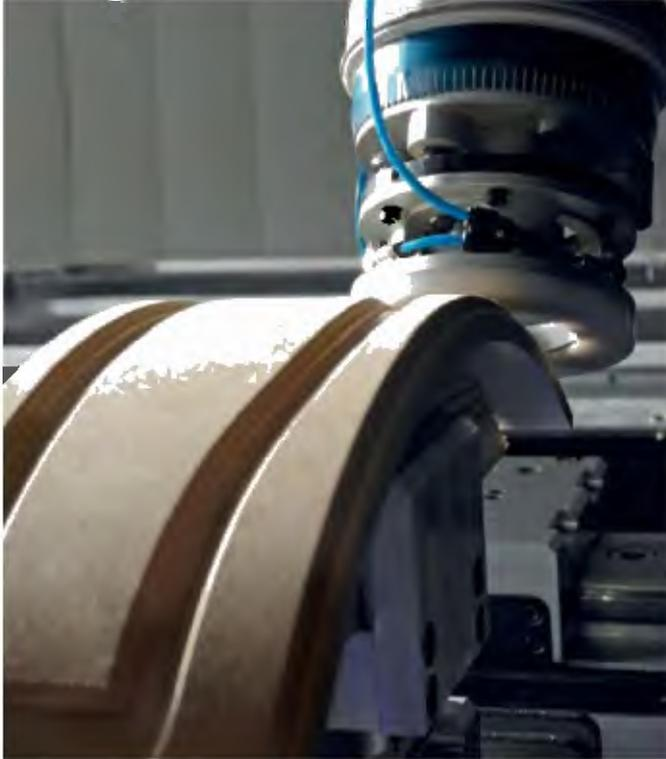

Standard aggregate use incl. controlled compressed air



Door processing



Tilts upwards 10°



Door frame manufacturing



Sharpening of corners



Lock recess



Staircases



CNC processing in every format



Cabinet production



Clamex-P



Simultaneous 5 axes processing



3D applications

Vacuum pods and clamping systems

Types of vacuum pods for hose free 2 circuit hose system



Schmalz vacuum block pod 2 circuit console system height 100 mm

POS	Name	L x W	X/Y	Order no.
1	Vacuum pods	140 x 115	-	300-05-910
2	Vacuum pods	125 x 75	X	300-05-911
3	Vacuum pods	125 x 75	Y	300-05-912
4	Vacuum pods	125 x 75 (rotatable by 360°)	-	300-05-913
5	Vacuum pods	125 x 50	X	300-05-914
6	Vacuum pods	125 x 50	Y	300-05-915
7	Vacuum pods	125 x 50 (rotatable by 360°)	-	300-05-916
8	Vacuum pods	130 x 30	X	300-05-917
9	Vacuum pods	130 x 30	Y	300-05-918

Version with height of 125 mm, 50 mm and 75 mm ("s-motion" on the H500) on request



Perfect nesting with the FORMAT-4 matrix table

The nesting table with optimal matrix geometry can be placed directly on the consoles and enables the full panel support of workpieces of any size and design, guaranteeing their exact positioning.

Frame clamps



For all clamping ranges and every shape of frame

2 vacuum circuit holds the frame clamp to the console and locating pins ensure maximum repeatability. Clamping requires 6 bar compressed air. The ability to lower the base plate by 3 mm (excluding positions 10 + 13 + 16) guarantees simple re-clamping when moving from inner to outer profiles. There are various different plate shapes available, depending on the amount of clamping force required.

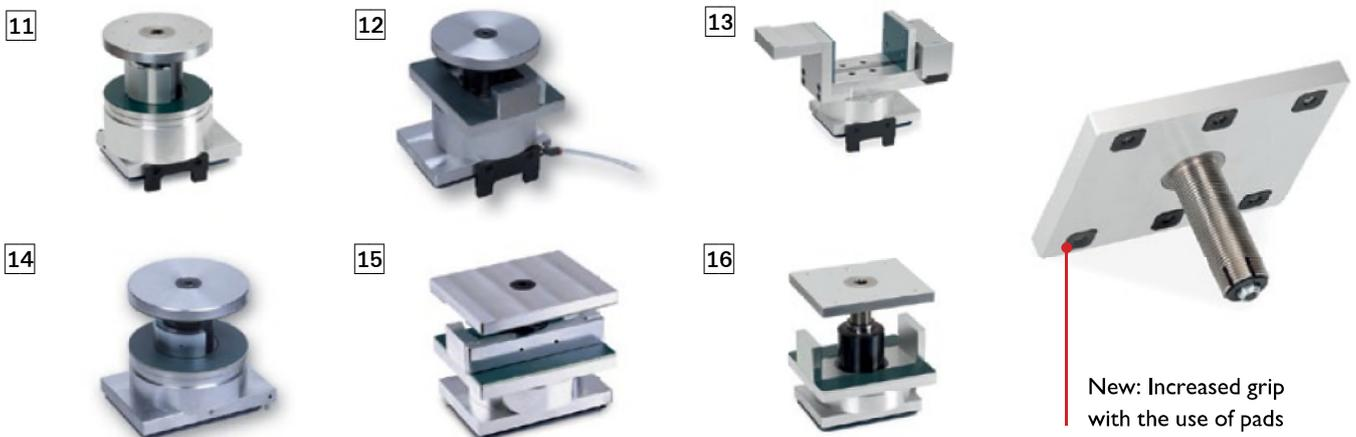

New: Increased grip with the use of pads

Frame clamps profit H200/H350/H500

POS	Name	Clamping range
11	Frame clamp (with locking flaps using via compressed air)	55–105
12	Single piece frame clamp (with locking flaps using compressed air)	55–105
13	Frame clamp with horizontal clamps (with locking flaps using compressed air)	0–135
14	Frame clamps for e-motion consoles (using compressed air)	55–105
15	Single piece frame clamp (using compressed air)	55–105
16	e-motion frame clamp with horizontal clamps	0–135



Frame clamp accessories profit H200/H300/H350/H500

POS	Name	Clamping range
14	Clamping plate	15–65
15	Clamping plate	55–105
16	Teardrop shaped clamping plate	55–105
17	Teardrop shaped clamping plate	55–105
18	Rectangular clamping plate	55–105

Control

Status indicator

The changing colours of the innovative lighting system display the various machine statuses. This makes it possible to keep up-to-date on the current status of your profit CNC machining centre.



Fixed or mobile control terminal

Large 24" LED colour screen for the clear display of the control software. Depending on the safety system chosen, the control terminal can be fixed or mobile.

Green Line

The Green Line Package reduces the energy consumption when the machine is not being used or only running at partial capacity.



Aggregates

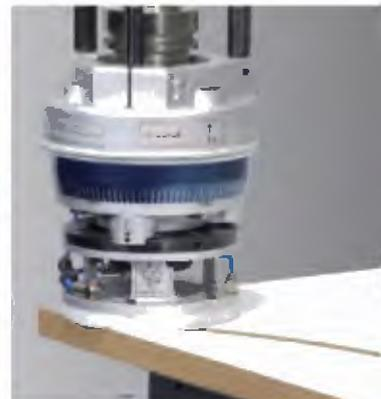
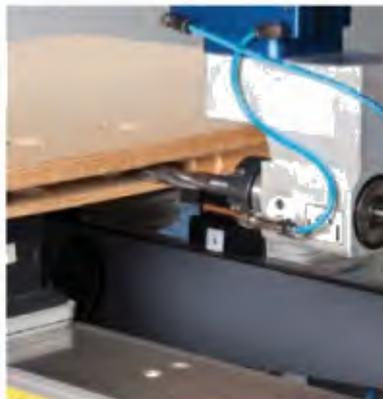

HSK F63 Single angle head, for use with a drill bit or a router with I connection
Order No. 300-24-001



HSK F63 Single angle head, for use with a screw mounted saw blade with one WELDON connection,
max. Ø 180 mm **Order no. 300-24-002**
max. Ø 240 mm **Order no. 300-24-003**
max. Ø 300 mm **Order no. 300-24-007**



HSK F63 Single angle cutter, for use with a saw blade with I connection (ATLOCK lock),
max. Ø 240 mm **Order no. 300-24-009**
max. Ø 300 mm **Order no. 300-24-008**



HSK F63 Door lock aggregate with I connection ER 32 for drill bits and router tools with two compressed air jets and I connection at the rear, ER 16 for drill bits or router tools
Order no. 300-24-017



HSK F63 Floating unit for vertical copying of the exact routing depth HSK F63
Order no. 300-24-034



HSK F63 Dual angle head with 2 connections, ER 25 drill bit and router tools
Order no. 300-24-011



HSK F63 Dual-sided angle head with 1 connection for ER 25 drill bit and router tools and 1 WELDON connection with screw mounted saw blade, max. Ø 180 mm **Order no. 300-24-012**



HSK F63 Four-sided angle head with 2x ER 25 connections for drill bits and routing tools and 2x ER 32 connections
Order no. 300-24-014
4 ER 25 connections
Order no. 300-24-015



HSK F63 3+1 angle head with 10 mm chucks, spaced at 22 mm
Order no. 300-24-016



HSK F63 tilting aggregate with 1 ER 25 connection for drilling, routing or sawing tools, max. Ø 180 mm **Order no. 300-24-005**



HSK F63 single WELDON connection tilting head for saw blades with max. Ø 180 mm **Order no. 300-24-006**



HSK F63 tilting aggregate with 1 ER 25 connection for drilling, routing or sawing tools, digital, max. Ø 240 mm angle adjustment and quick connection
Order no. 300-24-026



HSK F63 tilting aggregate digital with ET interface for drilling, routing or sawing tools, max. Ø 180 mm angle adjustment and quick connection
Order no. 300-24-023



HSK F63 tilting aggregate, digital with ET interface for drilling, routing or sawing tools, max. Ø 240 mm angle adjustment and quick connector
Order no. 300-24-024



HSK F63 tilting aggregate with 1 ER 25 connection for drilling, routing or sawing tools, digital, max. Ø 180 mm angle adjustment and quick connector
Order no. 300-24-025

ET interface

- Repeatability
- Saves time when changing the tooling
- Exact reading of the angle to a 1/10th of a degree
- Fixed positioning (0, 90, 45 positions)

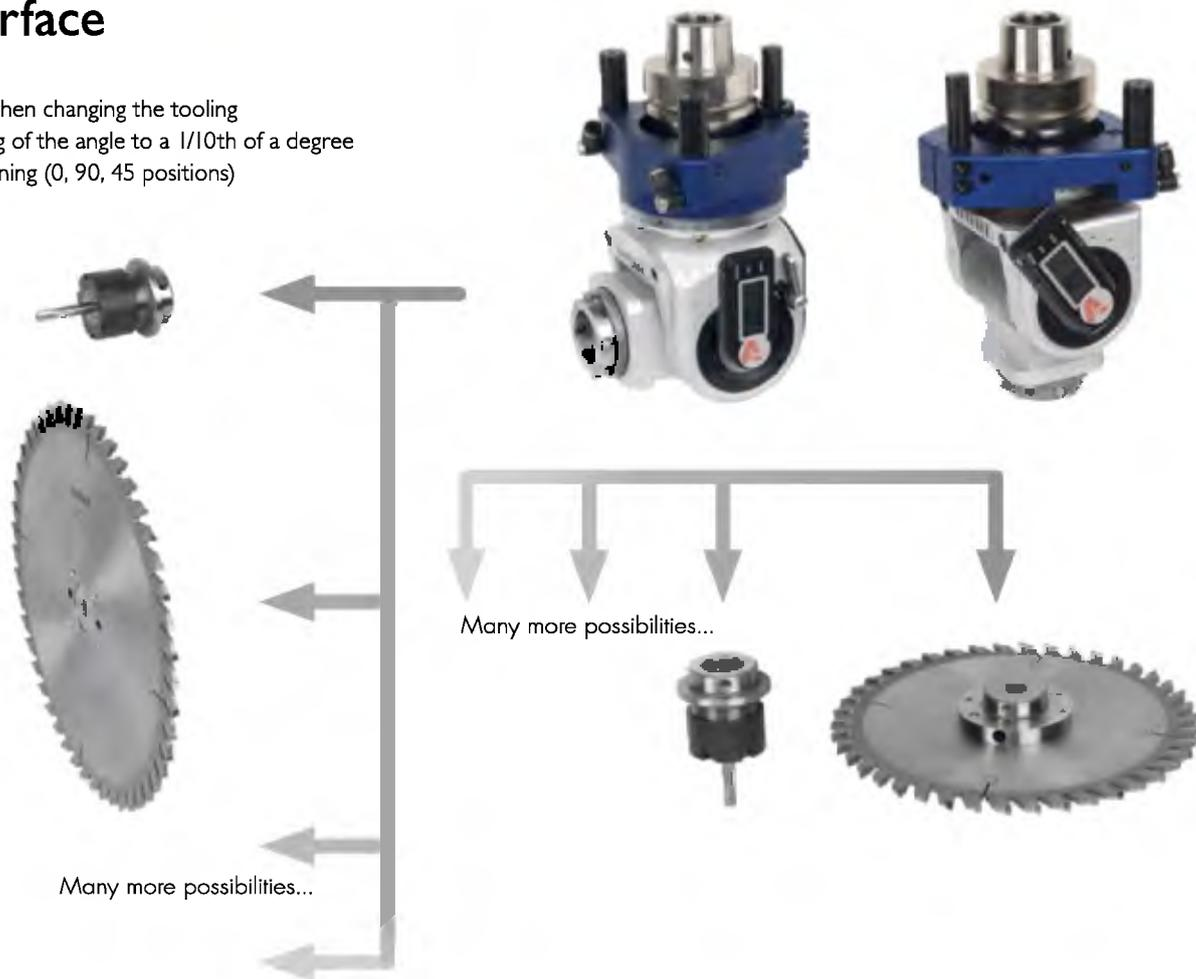

Accessories for the ET interface



ET adapter for the mounting of tooling onto aggregates with an ER 25 interface mini adapter for ET interfaces
Order no. 300-24-028

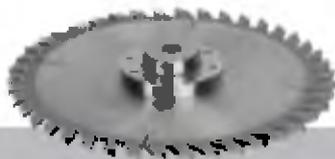

ET adapter for the mounting of tooling onto aggregates with an ET interface WELDON adapter for ET interfaces
Order no. 300-24-030



ET adapter for the mounting of tooling onto aggregates with a Clamex ET interface adapter for ET interfaces
Order no. 300-24-027

ET adapter for the mounting of tooling onto aggregates with an ET-set (1 x Weldon/2 x ER 25) ET interface
Order no. 300-24-031

ET adapter for the mounting of tooling onto aggregates with an ET interface ET-set (2 x WELDON/1 x ER 25)
Order no. 300-24-032

5 motion, the special aggregate from FORMAT-4

The 5 axis unit from FORMAT-4: Automatically adjustable to any position!

The automatically adjustable "5-motion" tilting aggregate from Format-4, makes it possible to affordably upgrade every CNC machine to a 4 and 5-axis CNC machine.

Low investment, high savings! With the use of an automatically adjustable Format-4 "5-motion" tilting aggregate, the performance and the efficiency of every CNC machine increases significantly. The automatically adjustable Format-4 "5-motion" tilting aggregate reduces investment costs for any additional tools or aggregates required. Additional savings are achieved through the shorter processing times (less tool change cycles for each workpiece), time and therefore money. In summary, the automatically adjustable Format-4 "5-motion" tilting aggregate offers every company, not only a quick return on the investment, but also secures the future value of the existing CNC machine.



5-motion^{plus}

The FORMAT-4 5-axis aggregate with tool interface

The "plus" stands for more tools, which can be used within one program. With the 5-motion^{plus} aggregate, saw blades, routers and drill bits can all be used within a single program and change automatically. The interface of the 5-motion^{plus} aggregates enables the tool change using the rear tool changer at the same speed as a standard tool change. The Format-4 5-motion^{plus} aggregate convinces with limitless flexibility and variety!

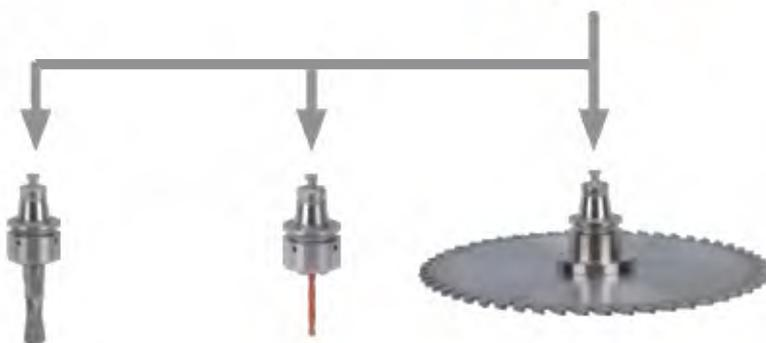

profit H08



CNC-Nesting - Efficiency in the smallest of spaces

The profit H08 from Format-4 is the CNC-machining centre for professional nesting applications with minimal space requirement. Especially developed for universal application, this profitable all-rounder convinces with top precision and impressive productivity when processing different materials.



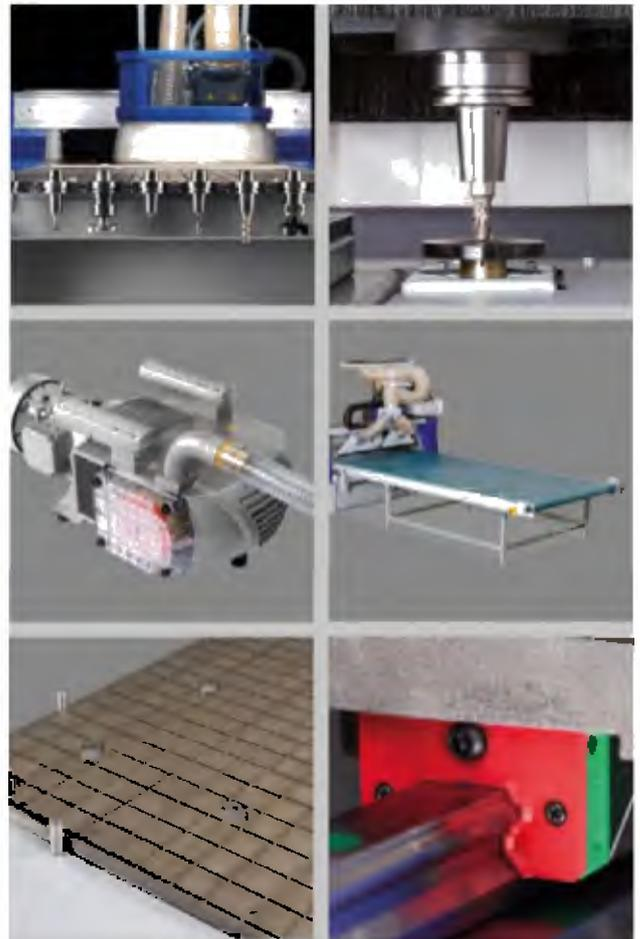

Portal design with gantry drive system

Automatic measuring system of the tool length

Up to 500 m³/h vacuum power

Automatic unloading unit including electric motor driven offloading pusher

Perfect nesting with the Format-4 matrix table

Additional seals for extreme operating conditions

FORMAT

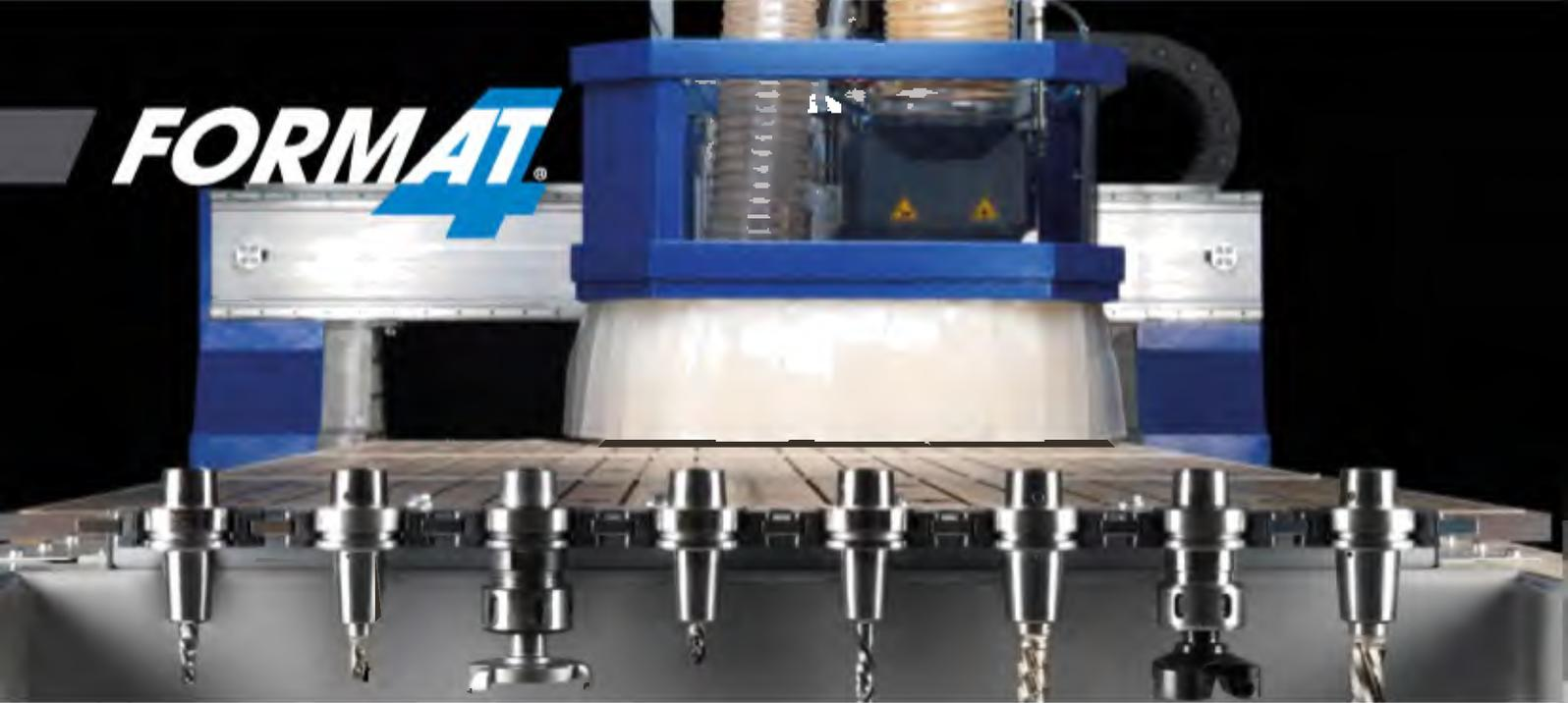

Working area

Milling and drilling in any desired shape, in a single working process

The dual side driven gantry on the profit H08 guarantees maximum precision and repeatability of your processes.

Perfect nesting with the Format-4 matrix table

The nesting table with optimal matrix geometry enables the full panel support of workpieces of any size and design, guaranteeing exact positioning. Reference stops mounted directly to the table offer additional support in reducing wastage and can be optionally equipped with collision protection sensors to monitor their position.



Vacuum fields

Vacuum fields that are individually selectable using rotary valves, guarantee a perfect vacuum for various materials and workpiece sizes.



Hand-held terminal

Hand-held terminal with potentiometer and emergency stop.



Gantry system

The rack and pinion drive in the X and Y direction ensures maximum traverse speeds for the shortest processing and tool changing times.

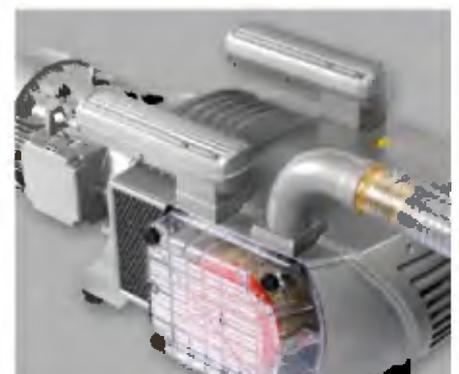

Vacuum system

250 m³/h or 500 m³/h instead of 180 m³/h.

Working areas, traverse distances

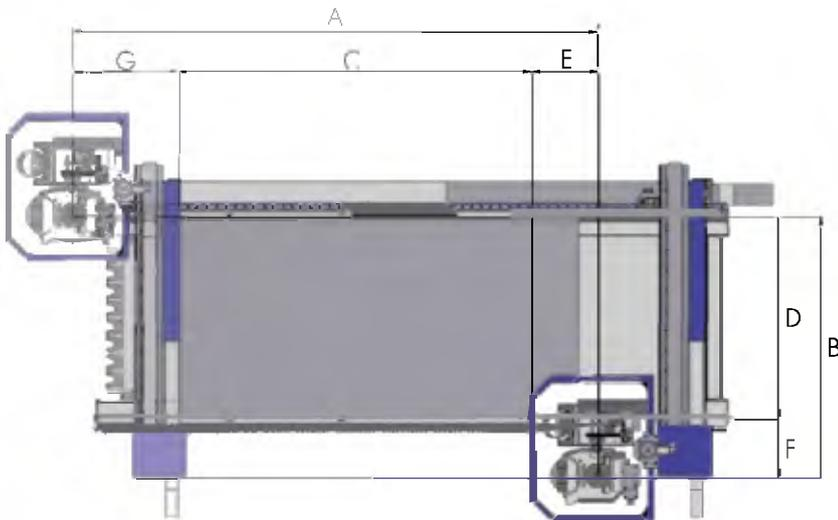

profit H08 13.25

- A 3,260 mm
- B 1,630 mm
- C 2,500 mm
- D 1,250 mm
- E 593 mm
- F 186 mm
- G 166 mm

profit H08 16.32

- A 3,860 mm
- B 1,930 mm
- C 3,090 mm
- D 1,530 mm
- E 593 mm
- F 186 mm
- G 176 mm

Drilling head



Drilling heads

- DH 8 drilling head, with 8 vertical spindles
- DH 12 drilling head, with 12 vertical spindles
- DH 16 drilling head, with 12 vertical and 4 horizontal spindles and 2 saw blades
- Inverter driven motor up to 6,000 rpm

The machine carries out vertical drilling.

DH 8

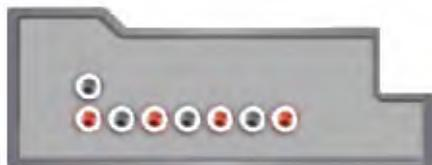

DH 8

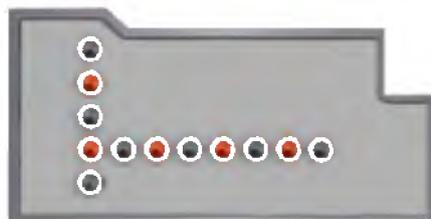

DH 12



DH 16



Spindle



"Professional" for maximum productivity and complete flexibility

In the professional package, the high performance routing spindle has a HSK-F63 tool chuck and together with the 10kW motor rotating at 24,000 rpm delivers perfect results even when machining difficult to process materials. Up to 10 tool positions ensure that a quick tool change is possible making the H08 even more productive.

Equipment package "start" for perfect routing results

The high performance routing spindle in the "start" package with an ER 32 chuck, 10 kW motor power and 24,000 rpm achieves first class results and highest precision with maximum productivity.

Automatic measuring system of the tool length

Parametrising your tools made easy: Each tool length in the database is provided with an accuracy of a hundredth of a millimetre.

Tooling positions and space requirements

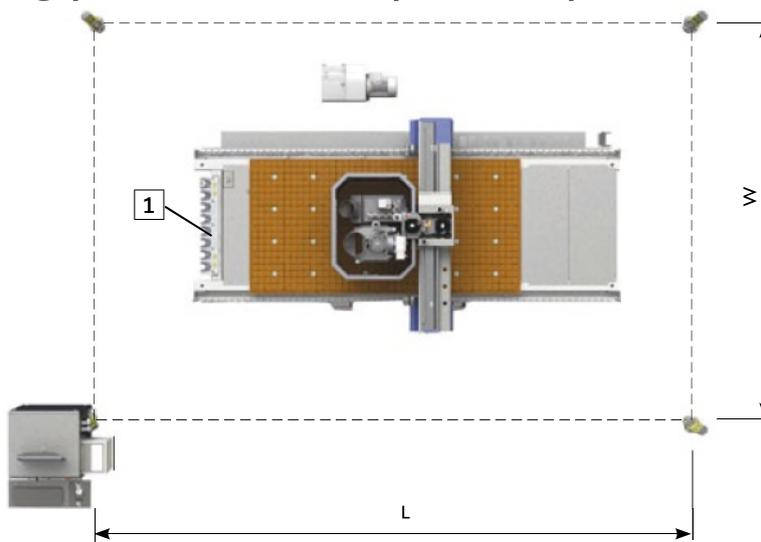

Symbolic image profit H08 13.25, profit H08 16.32



Tool changer

8- or 11 position tool changer on the side of the machine chassis

	profit H08 13.25	profit H08 16.32
Height [H]	1,650 mm	1,650 mm
Length [L]	5,600 mm	6,200 mm
Width [W]	3,790 mm	4,090 mm
Weight (depending on equipment, without packaging)	1,820 kg	2,330 kg

Dimensions given can vary if special options are selected

Vacuum pods

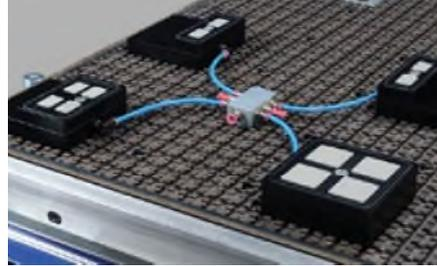

Quick and easy positioning of the vacuum pods, suitable for every workpiece size
The matrix design of the table, makes it easy to handle and position the pods. A distributor can also be used additionally, in order to be able to create a 2 circuit vacuum system.

Vacuum pods - positioned quickly
The hand-held terminal activates and positions the cross laser.

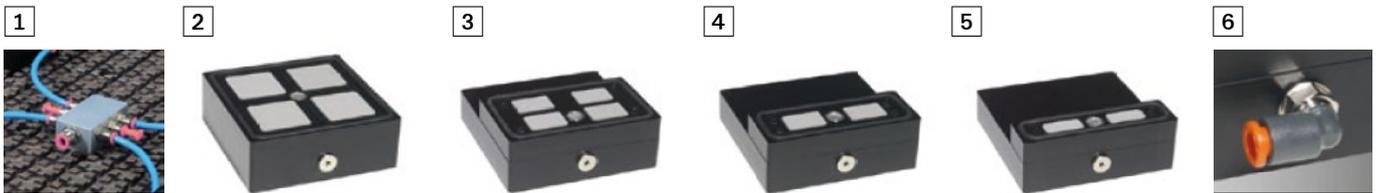

Vacuum blocks for the matrix table

POS	Name	L x W x H	Order no.
1	Distribution plate		300-05-964
2	Hose-free vacuum pods for MT nesting tables	126 x 126 x 40	300-05-960
3	Hose-free vacuum pods for MT nesting tables	126 x 75 x 40	300-05-961
4	Hose-free vacuum pods for MT nesting tables	126 x 50 x 40	300-05-962
5	Hose-free vacuum pods for MT nesting tables	126 x 35 x 40	300-05-963
6	Elbow joint for the adaptor connection		

Application examples profit H08/H10



Engraving



Edge processing



Mill threads

Application examples profit H10



Cutting foam



Lamello



Door panel



Chip deflector

profit H10

FORMAT

Efficiency in single person operation



The profit H10 panel formatting, drilling and milling centre brings a whole new level of efficiency to single person operation. In just one working process the CNC machining centre carries out formatting, drilling and nesting, guaranteeing maximum workpiece usage and minimum waste. The highly precise edge finish ensures that the workpiece can go on to the next stage of production without requiring any post processing.

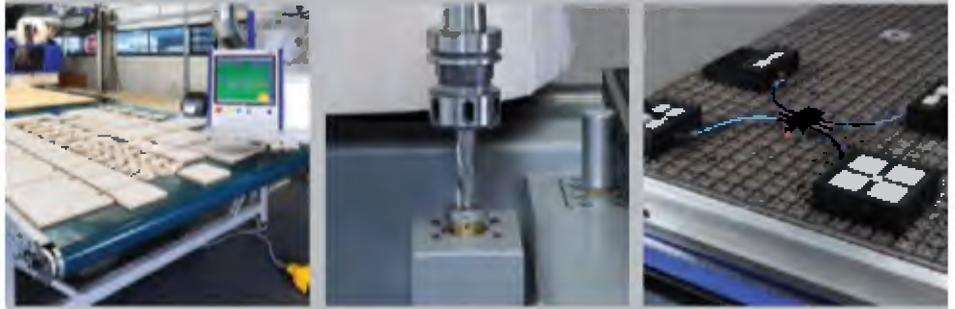

**Cut, push-off
and label**

**Automatic
measuring system
of the tool length**

**Quick positioning
of the workpiece
vacuum pods**

**Fence options for
additional flexibility**

**Sequential
vacuum**

**Use of a chip
deflector**

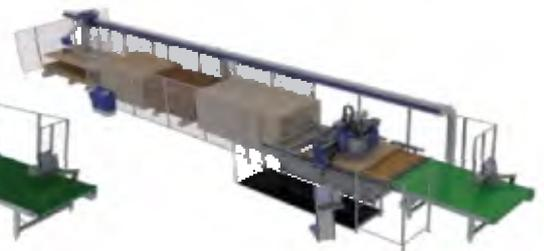

The machine illustrations may show optional equipment. Please refer to your individual quotation for clarification on which options are included.

Working area

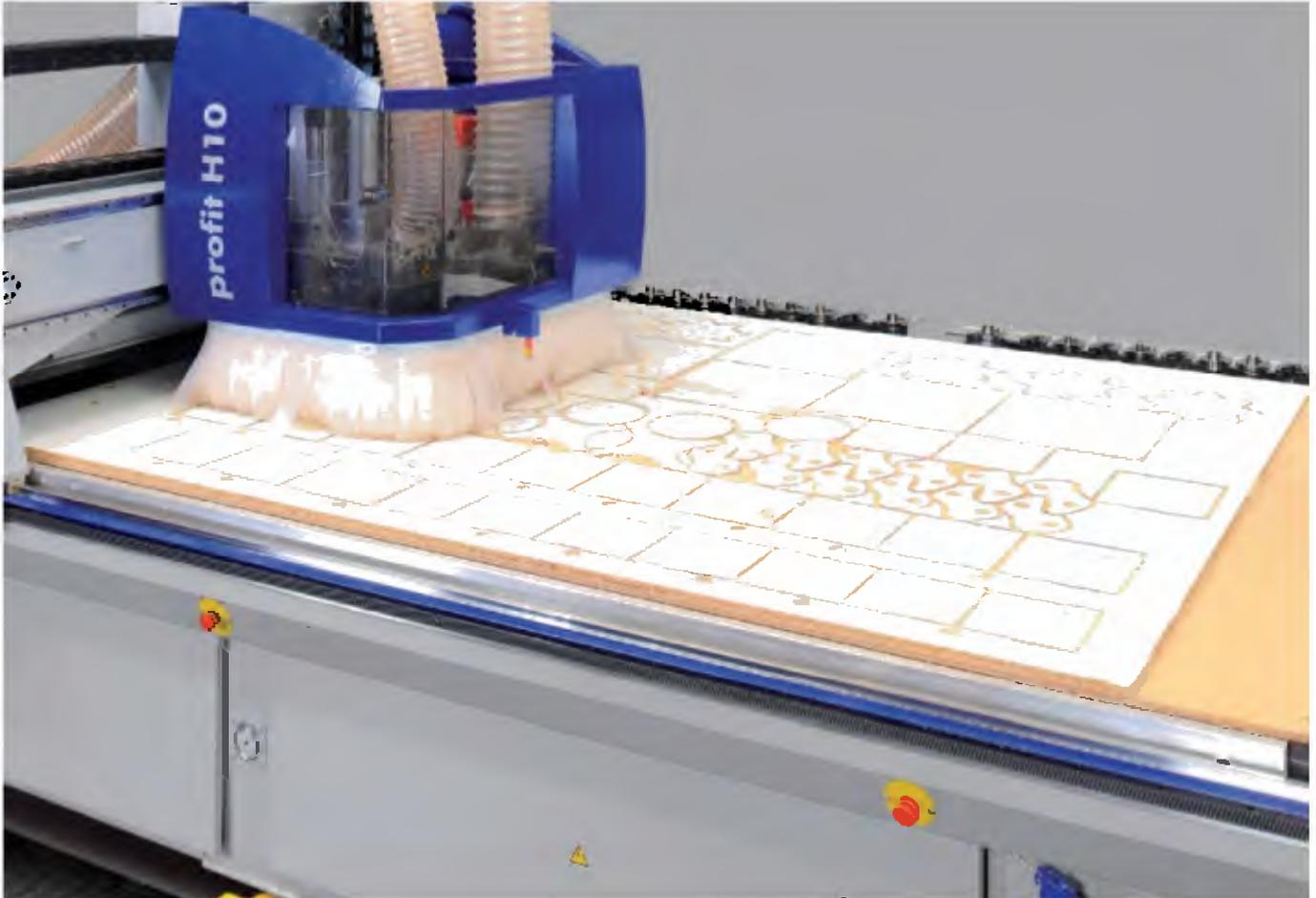

Panel cutting, drilling and milling in any shape desired, all in one process!

CNC Cutting

- Load panel, start working. Once loaded, the profit H10 works without an operator. No additional programming is required.

CNC Drilling

- Material does not need to be moved to another CNC or drilling machine.
- Significant time savings due to a combination of CNC cutting and CNC drilling in just one work cycle.

CNC Milling

- Matrix table can be fitted with vacuum pods; CNC milling operations can be carried out just as on standard CNC machines.

The gantry system of the profit H10 is driven on both sides guaranteeing maximum precision and repeatability. The rack and pinion drive in the X and Y direction ensures maximum traverse speeds and the shortest processing and tool changing times.

CNC-Nesting

- Any required shape is possible. Nesting software ensures minimum wastage.
- Significant time savings thanks to a combination of CNC cutting, CNC drilling and CNC nesting in just one working cycle.

Working areas, traverse distances

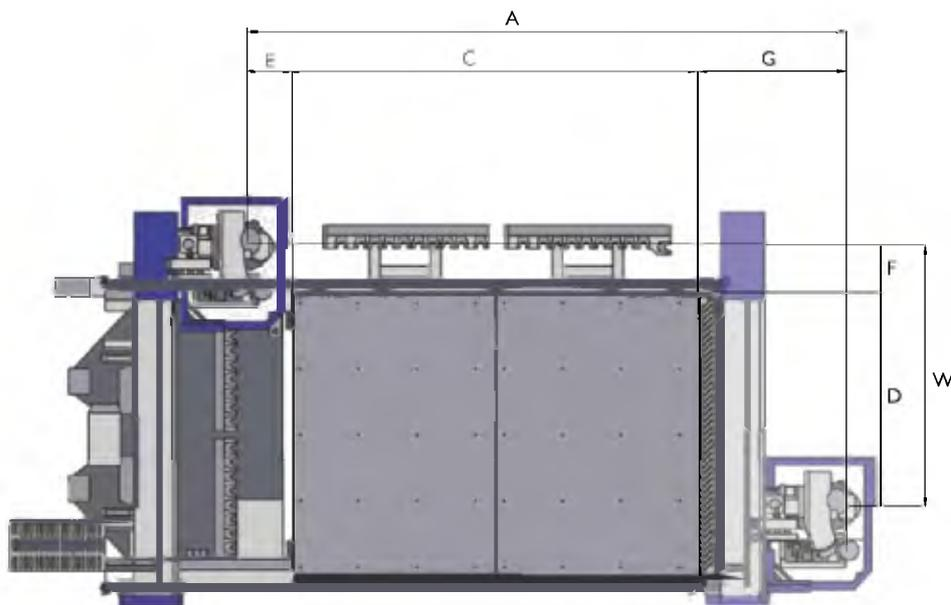

profit H10 16.38

- A 4,650 mm
- B 1,960 mm
- C 3,720 mm
- D 1,585 mm
- E 448 mm
- F 375 mm
- G 482 mm

profit H10 19.38

- A 4,650 mm
- B 2,260 mm
- C 3,720 mm
- D 1,885 mm
- E 448 mm
- F 375 mm
- G 482 mm

profit H10 22.32

- A 4,050 mm
- B 2,560 mm
- C 3,120 mm
- D 2,160 mm
- E 448 mm
- F 375 mm
- G 482 mm

profit H10 22.43

- A 5,250 mm
- B 2,560 mm
- C 4,320 mm
- D 2,160 mm
- E 448 mm
- F 375 mm
- G 482 mm



Drilling head

Regardless whether the machine will only be used for cabinet manufacturing or as an all-rounder, you can decide which drilling head configuration is the right one for you. Choose between, a head with only vertical drilling spindles or one with spindles and a grooving saw for vertical and horizontal processing. Inverter controlled motor up to 7,500 rpm.



DH 12



DH 16 4H 2S



DH 22 4H 2S

Spindle

With a motor power of 10 and 12 kW and up to 24,000 rpm, the main milling motor is controlled using an inverter and is attached directly to the support module of the drilling head in the Z axis. Dual linear guiding guarantees highly precise vertical guiding. The main milling motor is positioned using ground ball screws. The HSK F63 tool clamping is done automatically. The clamping of the tool is checked using sensors, which then confirm that it is safe to start the operation. The tool holder is cleaned pneumatically. The C-axis is available as the fourth axis and is interpolating (360°) with a compressed air interface for aggregates as standard.



Automatic measuring system of the tool length

Parametrising your tools made easy: Each tool length in the database is provided with an accuracy of a hundredth of a millimetre.

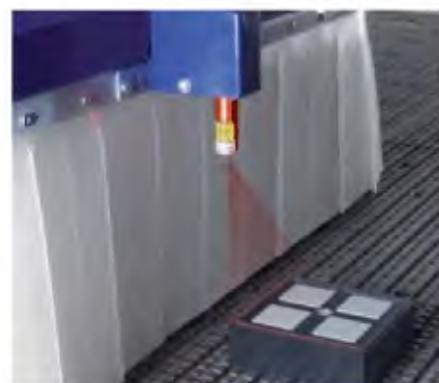
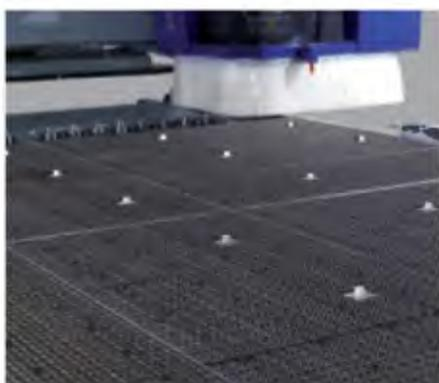

Loading supports

The distribution of the loading supports over the complete table assists particularly when it comes to handling of the spoil board.

Vacuum pods - positioned quickly

The hand-held terminal activates and positions the cross laser.

Tooling positions and space requirements

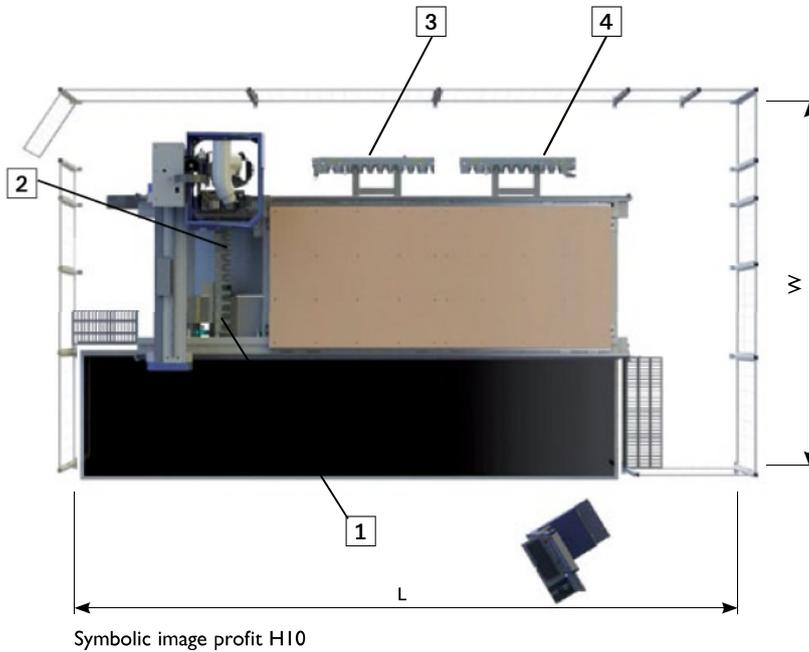

	profit H10 22.32	profit H10 22.43	profit H10 16.38	profit H10 19.38
Height [H]	2,510 mm	2,510 mm	2,510 mm	2,510 mm
Length [L]	6,800 mm	8,000 mm	7,400 mm	7,400 mm
Width [W]	4,750 mm	4,750 mm	4,150 mm	4,450 mm
Weight (depending on equipment, without packaging)	4,500 kg	4,950 kg	3,950 kg	4,150 kg



1 8 position linear tool changer mounted on the side of the machine chassis.



2 8 position linear tool changer mounted on the side of the machine chassis.



4 10 position linear tool changer mounted on the rear of the machine chassis.



3 10 position linear tool changer mounted on the rear of the machine chassis.

Dimensions given can vary if special options are selected

CNC aggregates

Tool change

The linear toll changer allows extremely quick tool changes and minimum compressed air usage. Use of aggregates with large tool diameters for increased performance of your profit H10.

Up to 36 tool and aggregate positions are available.



5-motion/5-motion^{plus}

Automatically adjustable to any position!
5-motion/5motion^{plus} tilting aggregate and your CNC becomes a 4.5 axis machine.



HSK F63 Knife aggregate for foam, leather and various other materials.

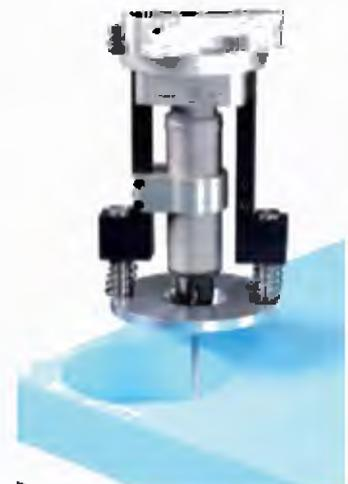

Cut, push-off and label



The integrated unloading unit on the portal pushes the finished workpiece out and at the same time cleans the table. Any residual dust and chips are removed by the below table extraction. During the pushing off process, the first label will be printed and the workpiece that is to be labelled will be shown in colour on the label printer screen. This procedure is then repeated for all of the workpieces.



Fence options

As an option, the fences can be equipped to either the front left or right. This ensures maximum operating comfort and additional flexibility when processing workpieces. On automatic machines the continuous fences ensure a steady off load on to the conveyor belt.



Intuitive programming



Direct data transfer

Required processing



Cabinets on console machines



Cabinets on matrix tables



Cabinets, tables, doors (internal)



Staircases import, 2D/3D free form pieces



Doors/windows (frame processing)

High end quality
of the finished product

Your path to
happy customers!



F *SOLUTIONS*

CNC Machining Centres

F4Design
Cabinet generator



profit H200, profit H300,
profit H350, profit H500

F4Design +
Flash Nest



profit H08 , profit H10

F4Design
(Gold/Platinum)



profit H200, profit H300,
profit H350, profit H500,
profit H08, profit H10

F4Solid



profit H200, profit H300,
profit H350, profit H500,
profit H08 , profit H10

Flash Frame



profit H200, profit H300,
profit H350, profit H500

Woodflash 4.0 design

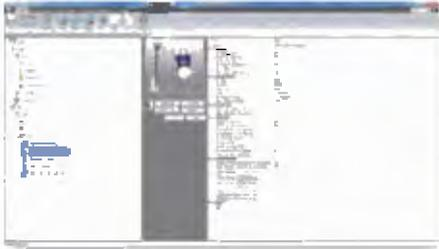

Tooling archive

Tool database: Diameter, length, speed, feed rate, etc.



Equipment

Machine tool management

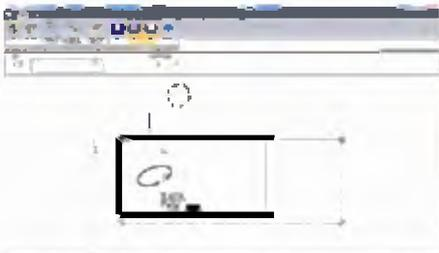

2D simulator

Fast calculation of machining times



Simulation Board

3D simulator/CNC Board

Optional: accurate representation of your machine as a 3D model incl. collision control

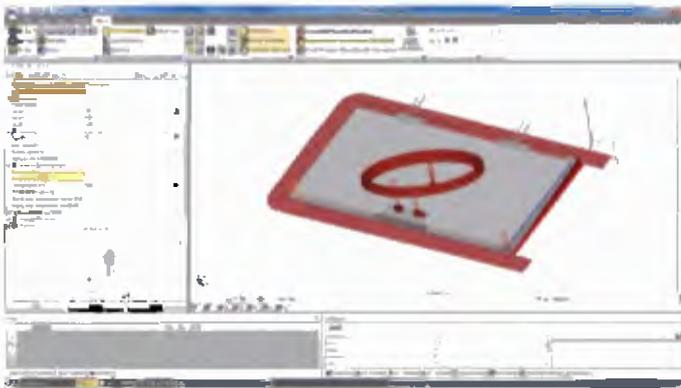

CNC-Editor: intuitive data entry

With Format-4, CNC comfort already starts at the planning phase. Save time and money with every work process.

- Programming of each component to its final size
- DXF-Import as a standard solution
- Variable programming, quick and simple
- Simple management of subprograms
- A variety of macros facilitate the programming, even with complex workpiece designs



3D simulator with collision control

With the 3D simulator the travel distance, feed speed, overhead height and equipment options such as a 5-motion aggregate, the chip deflector, all rotary tool changers and drilling heads are accurately displayed and the exact total processing time can be calculated.

The collision check tests whether any collisions could happen and guarantees the working safety on the machine. Through the allocation of the tool DXF profile, the contour of your router can be shown on the workpiece. Even when calibrating new tools, the DXF profile can be used which helps to reduce the amount of material use.

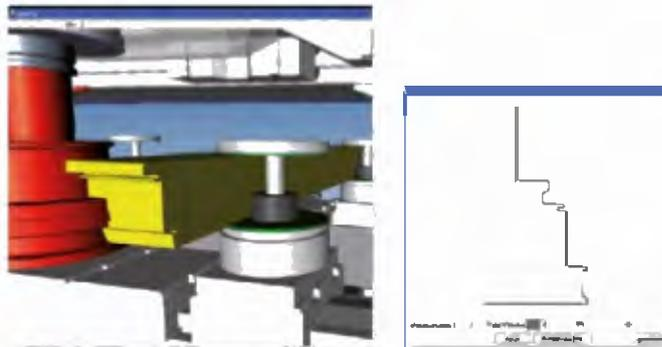

Woodflash module: Extruded surfaces with embossing and projection function

The milling in surface 1 is generated using the predefined contour in the side surface. Pockets, free contours or DXF imports make it quick and easy to be able to project or engrave on to the milled surface. The defined tool moves precisely at a right angle to the predefined contour on the side. (Option C403 required)

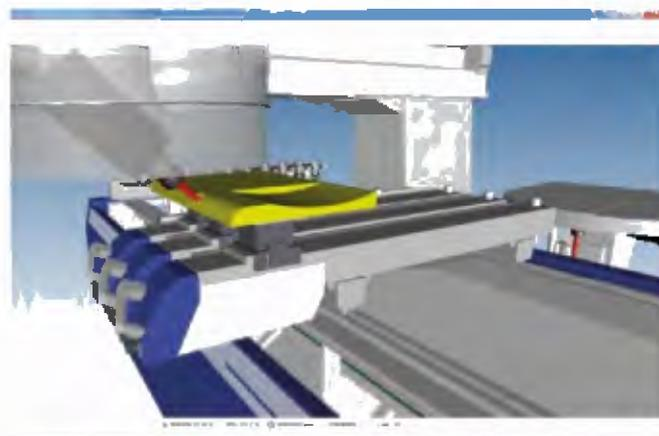

5 axes programming, quick and simple!

With the easy to program Format-4 software, routers can also be used for bevelling. Get the most from your 5 axes machine and reduce your tooling costs.

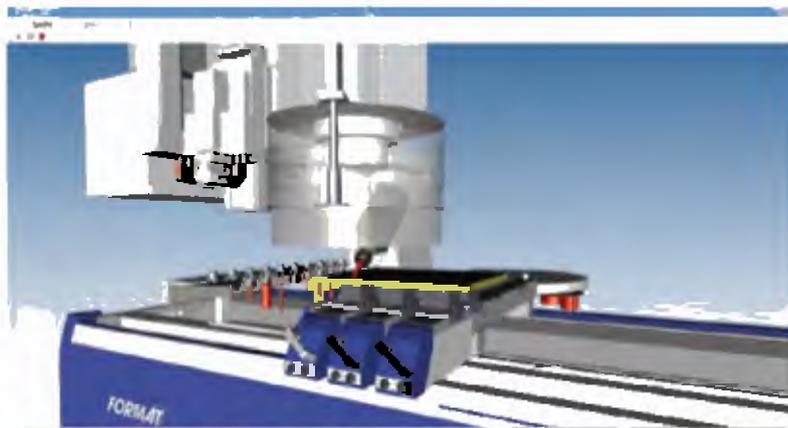

F4Design

Normally you have to choose between two software construction types.

Format-4 has however combined the advantages of both options to make an innovative complete solution.

Cabinet generator

- + Unbelievably easy and intuitive to use
 - + No CAD knowledge required
-
- Limited possibilities

Generating the cabinet in CAD

- + Countless more possibilities in the view
 - + Processing of individual components and construction scope
-
- CAD knowledge required

F4Design

F4Design is the first software that combines both. In the basic version (F4Design) the entry of the cabinet information is predominate in a generator style. As you move up to F4Design Gold and Platinum, CAD applications can also be used to adapt the cabinets generated by the generator.

Here special attention for woodworkers has been made, to create a tidy and clear visual appearance for the software. The CAD scope is sufficiently integrated, and does not cause any confusion with possibilities that are not required for kitchen/furniture cabinet or interior decoration.



F4Design – the cabinet generator

- Display of the cupboards in 3D
 - ↳ Line and shaded representation (wood structure)
- Selection of different basic shapes
- Graphic construction display (easy to change)
- Large choice of fronts, handles, materials, decoration and fittings etc.
- Creation of cupboards in an attic roof
- Creation and saving of material and construction plans
- Save created cupboards in the library
- Simple operation - no CAD knowledge required
- Selection and allocation of the fittings
- Part list export into Excel
- Cutting list export to Ardis

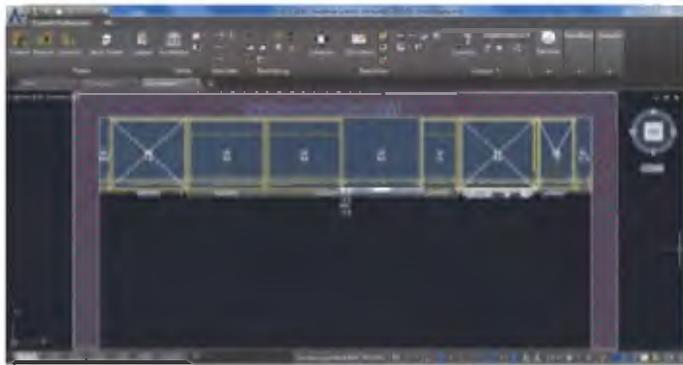

F4Design – Gold (extension of F4Design)

- Creation of panels
- Creating of individual components (incl. cutouts)
- Drawing of rooms (incl. windows, doors) for realistic presentation
- Creation of individual component drawings
- Inserting of dimensions (furniture, layout)
- Definition of views and section planes
- Diverse drawing commands
- Manual insertion of previously finished processes

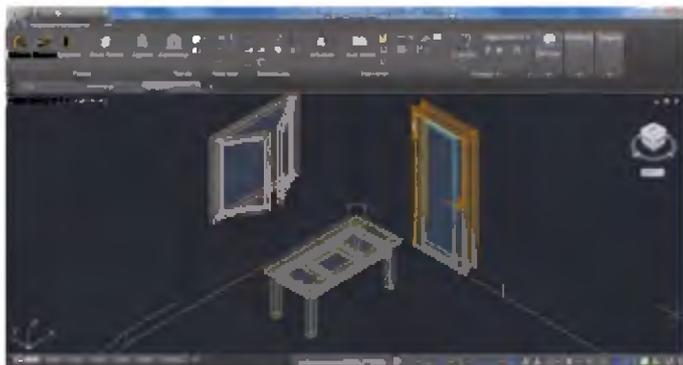

F4Design – Platinum (extension of F4Design Gold)

- Rendering module for the photo realistic display of the drawing (Presentation)
- Expansion of the design database (processes, profiles, decoration articles, etc.)
- Creating of individual processes (of individual components)
- Additional processing and drawing commands

Flash Frame

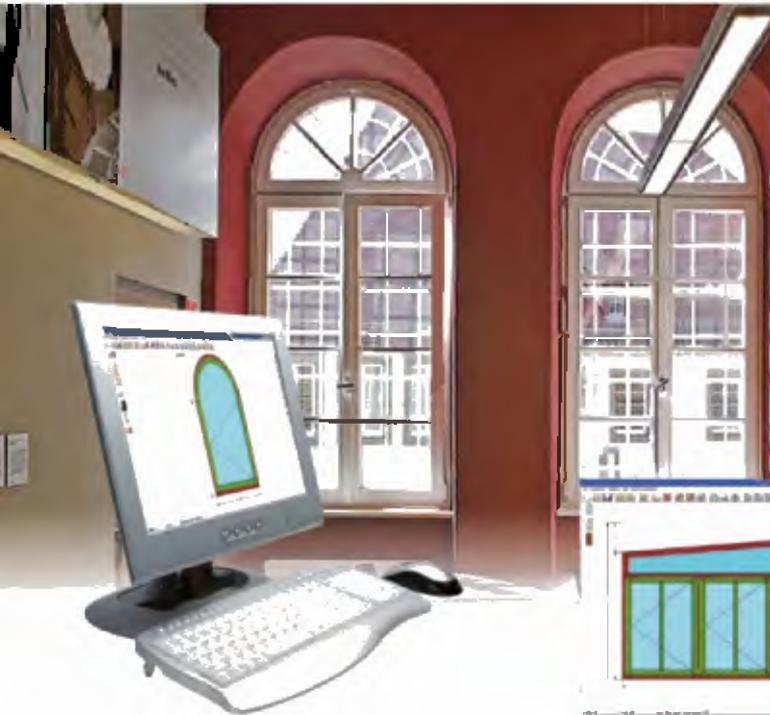

Every window shape at the click of the mouse

By entering just a few parameters you can design the frames and fillings of your doors and windows. Relevant parameters are for example: Size, corner connections with or without glass beads, fittings and much more. With the click of the mouse, the window will be broken down in seconds to individual CNC programs. Without any extra work, the machine operator can then load these files from the production planning and run them. A material list will be automatically generated with the image of the window.

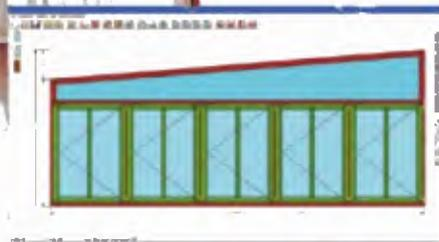

Rebate

- Directly from Flash Frame
- No post processing
- For every thickness
- Regardless of the rung width



Counter connections with milled tenons

- Exceptional stability
- Absolutely precise production on the CNC machining centre
- Efficient finish without dowel boring and dowels
- Flexible application in all window and door systems



Brand new from 2016:

Flash Frame also with 3D application!



FlashNest - Optimisation software for nesting

Planning, drawing, constructing & transferring CNC programs

The Format-4 programming software is an intuitive, self-explanatory software for modern program generation. The CAD functions make it possible to carry out planning and construction as easy as the visualisation of the programmed workpiece in 3D. The import possibility of DXF file formats also makes it possible to have a file transfer from an external branch software e.g. from architects and planning companies.

Material saving shape processing: Nesting with "FlashNest"

Shape processing, such as the nesting for upholstery components. The matrix table ensures the full surface support of the workpiece. FlashNest", the Format-4 nesting software, will calculate the maximum number of shapes possible per panel and minimise the amount of scrap material produced.

New macro with individual possibilities

- Selection of rough-finish option
(Tool input individually for rough and finish work)
- Selection from 2 different Z depths
- Contour offset selection

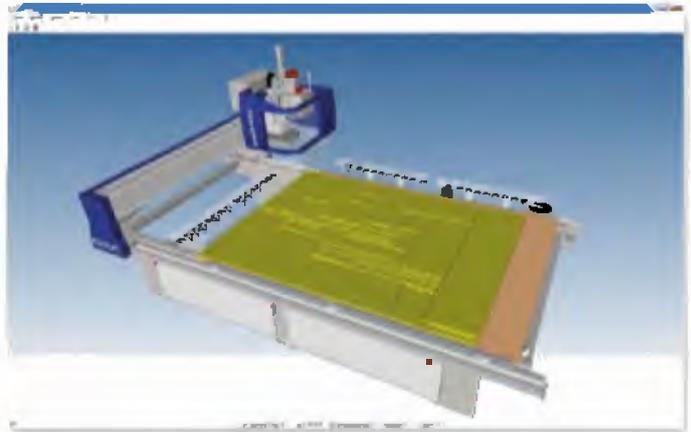
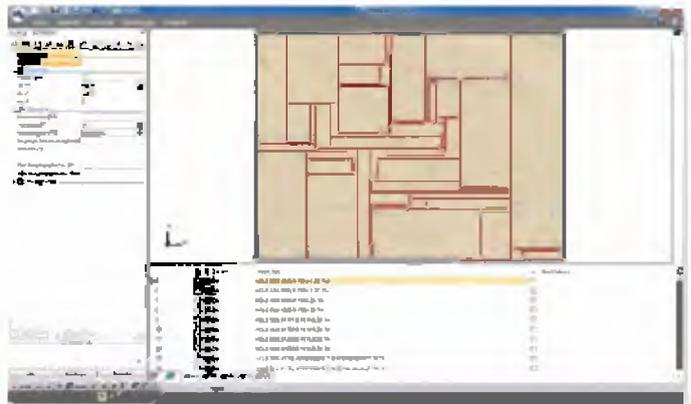



F4Solid powered by **alphacam** – the 3D solution for all **FORMAT-4** machining centres!

With F4Solid you can choose between the following three basic modules:

F4Solid3AX
version for 3 axes



F4Solid4AX
version for 4 axes



F4Solid5AX
version for 5 axes



1 Loading the 3D information ...



2 ... simplest creation of the tool path ...



F4Solid – Options

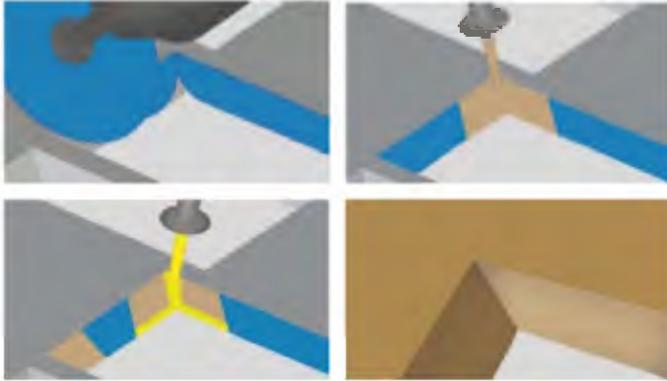

Sawing module

Real 5 axes saw module with cycle output and corner finishing

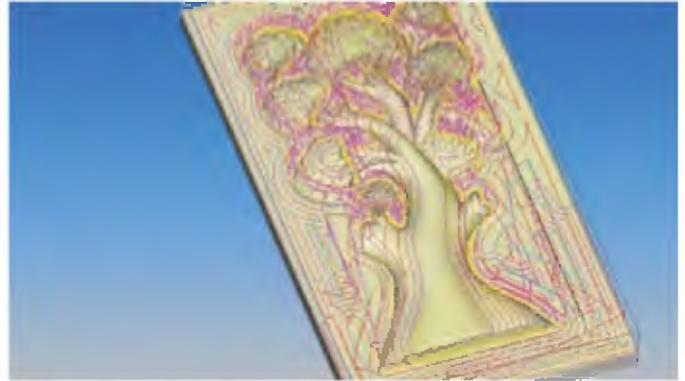

Solid Import

Inventor, Parasolid, Solid Edge, Solid Works, STL, DWG; DXF, IGES, Rhino, STEP



Surface generator

Simple creation of surfaces (rotation surfaces), TAB - surfaces (from 2-4 curves), edges - surfaces (from 2-4 curves), extruded surfaces, rounding off of 2-3 surfaces, surfaces from cuts, flat surfaces)

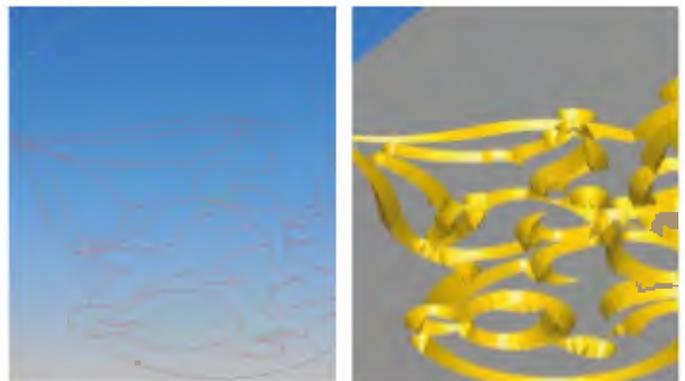

3D engraving

three dimensional engraving (with sharpened corners)

3 ... three-dimensional simulation of the production with a view of the finished workpiece ...



4 ... high quality end product and happy customers.



Visit us online and discover more about:

- Machines
- Videos
- Current promotions
- Tooling and accessories
- All technical information

www.format-4.com



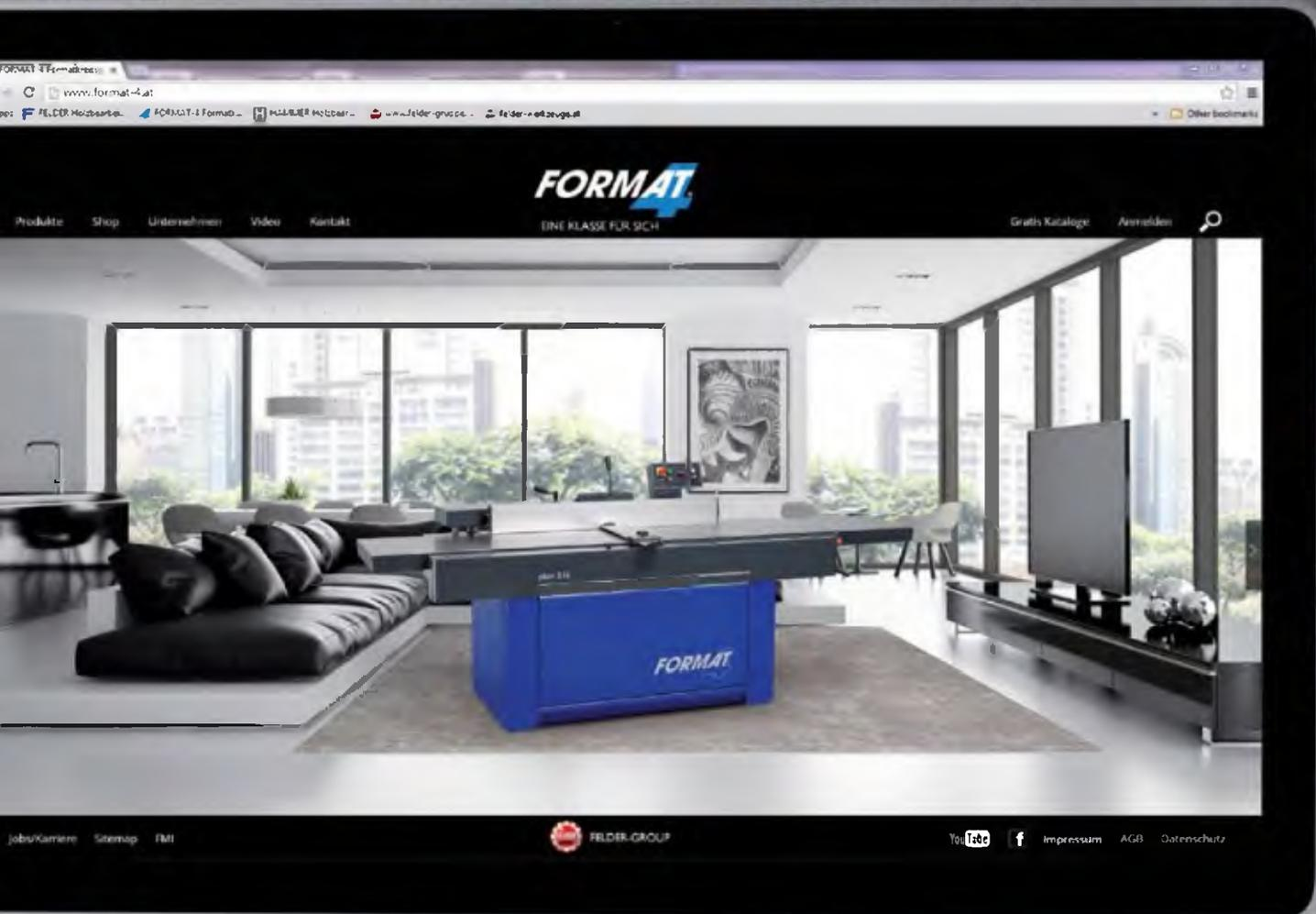
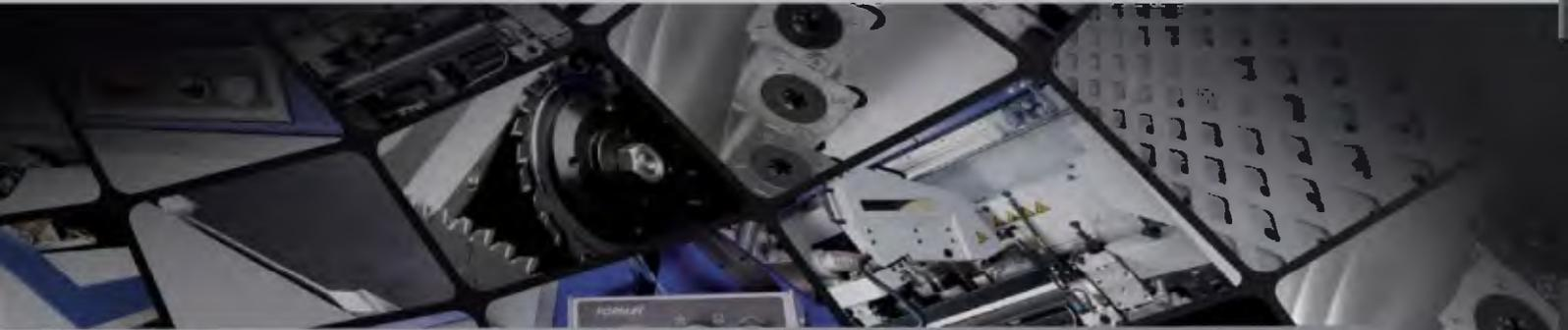

FORMAT

FORMAT



tempora

Saving you time
is our motivation



tempora

FORMAT®

Saving you time
is our motivation



Time, the most important resource in a modern workshop was one of the main focuses whilst developing the new tempora machine concept. Processing edges needs to be as quick, easy and efficient as possible. To achieve this, the tempora model combines the key characteristics of speed, productivity, flexibility and user comfort in a convincing complete package.

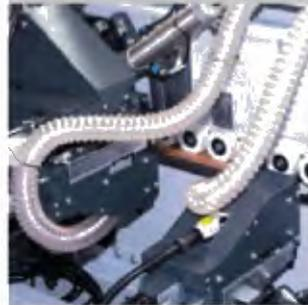

Premilling unit
with separately
controlled diamond
milling cutters

Two motor corner
rounding unit

Precise cuts
for every application

Control panel
with 10.4" colour
touch screen

Short heating up time,
tool-free quick-change
system

Airmotion hot air unit



tempora 60.08 x-motion plus



tempora 60.12 x-motion plus & e-motion

x-motion plus & e-motion control

The Format-4 control system x-motion plus and e-motion offer the customer a quick overview of the various processing steps of the machine and enable self-explanatory, uniform and above all quick and uncomplicated operation of the machine.

Control panel/display

- 10.4" colour touch screen
- Easy, self-explanatory representation of the units and their functions
- Activation from the control panel
- Ergonomic design (tilt, rotate and tip the control unit)

Operation/handling

- Aggregate adjustment with an increment of 0.01 mm electrically controlled from the control panel
- Automatic glue temperature monitoring as well as temperature settings for stand-by times and processing PUR

We make it easier to collect and analyse the processing information by providing:

- A count of the running metres (total running metres and customer specific orders)
- A count of the working hours
- Monitoring of the user information and reset function of the individual programs
- User software
- Individual setup settings in order to guarantee special processes
- Automatic positioning of the multifunction trimming unit for flush, radius and bevel trimming

Maintenance systems and service

- Integrated maintenance software with step by step instructions for the operator
- Plain text error messages
- Available network connection for the machine
- Optional uncomplicated maintenance and direct entry by the customer service technician on to the machine via the network connection
- External USB connection for software updates and data backup

Manual adjustments with x-motion plus control:

- Pressure unit, pressure bar, premilling depth corner rounding unit, glue scraping unit, radius scraping unit

With the e-motion control, all of these aggregates are automatically positioned.

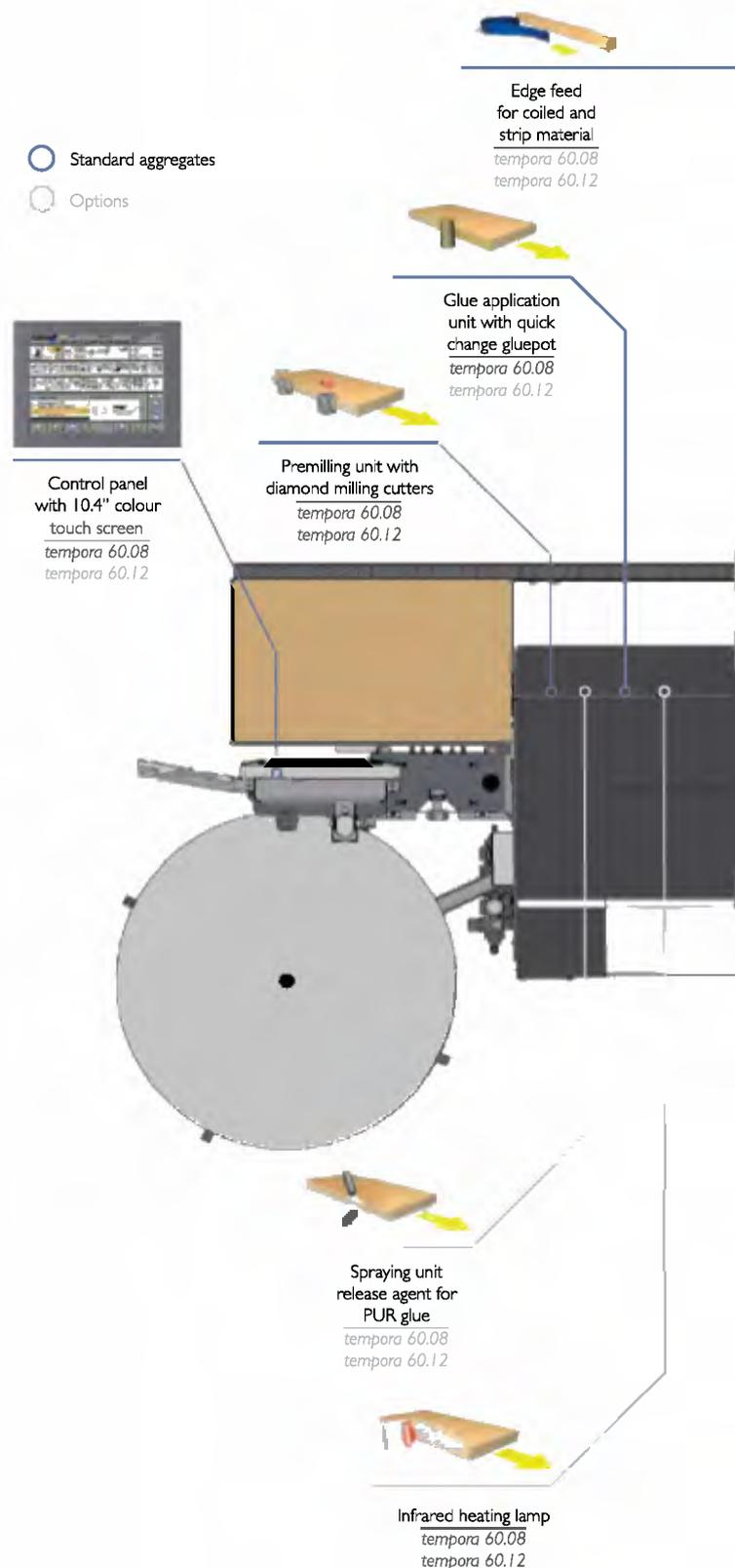

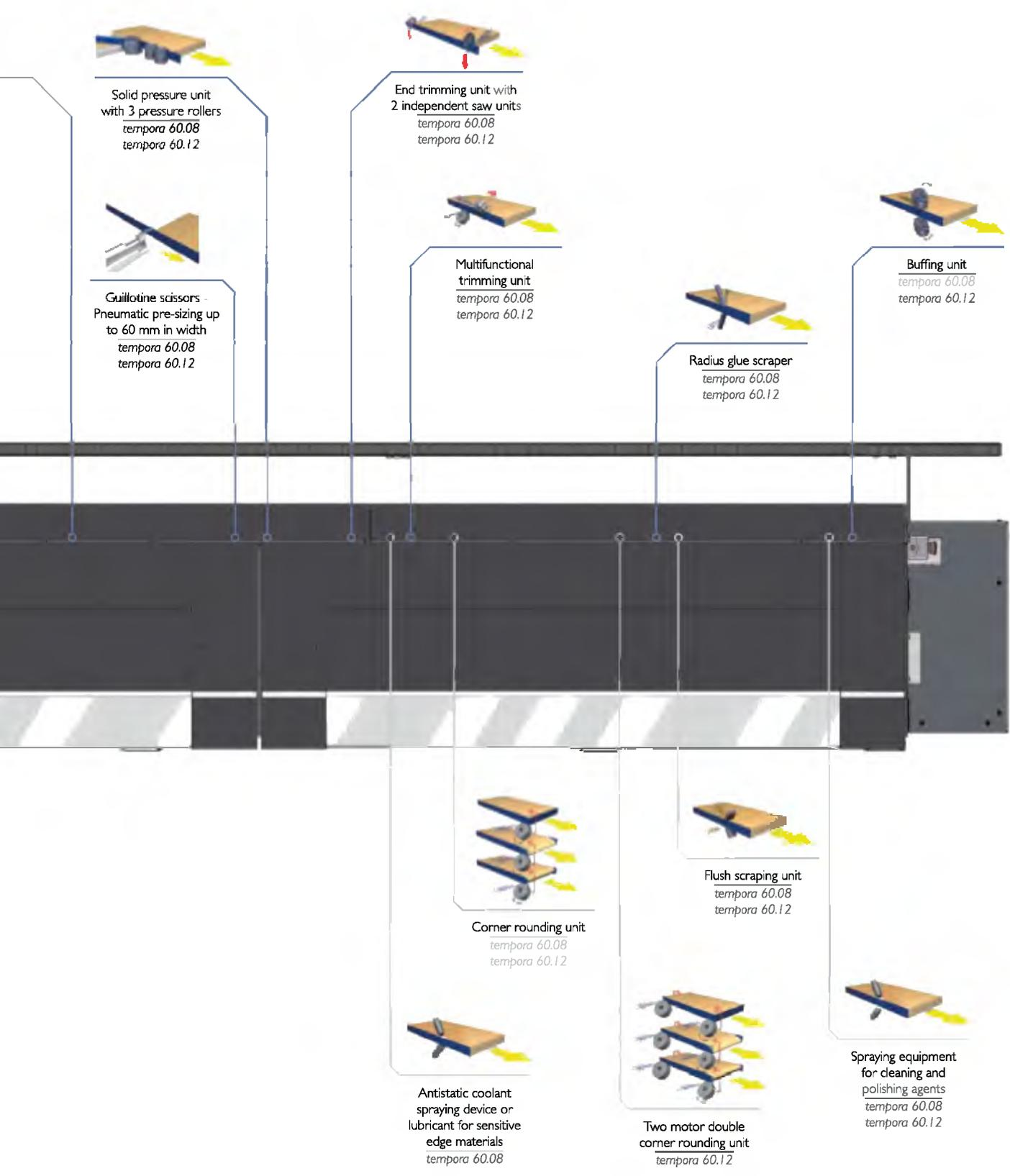

Solid pressure unit
with 3 pressure rollers
tempora 60.08
tempora 60.12

End trimming unit with
2 independent saw units
tempora 60.08
tempora 60.12

Guillotine scissors -
Pneumatic pre-sizing
up to 60 mm in width
tempora 60.08
tempora 60.12

Multifunctional
trimming unit
tempora 60.08
tempora 60.12

Radius glue scraper
tempora 60.08
tempora 60.12

Buffing unit
tempora 60.08
tempora 60.12

Corner rounding unit
tempora 60.08
tempora 60.12

Flush scraping unit
tempora 60.08
tempora 60.12

Antistatic coolant
spraying device or
lubricant for sensitive
edge materials
tempora 60.08

Two motor double
corner rounding unit
tempora 60.12

Spraying equipment
for cleaning and
polishing agents
tempora 60.08
tempora 60.12

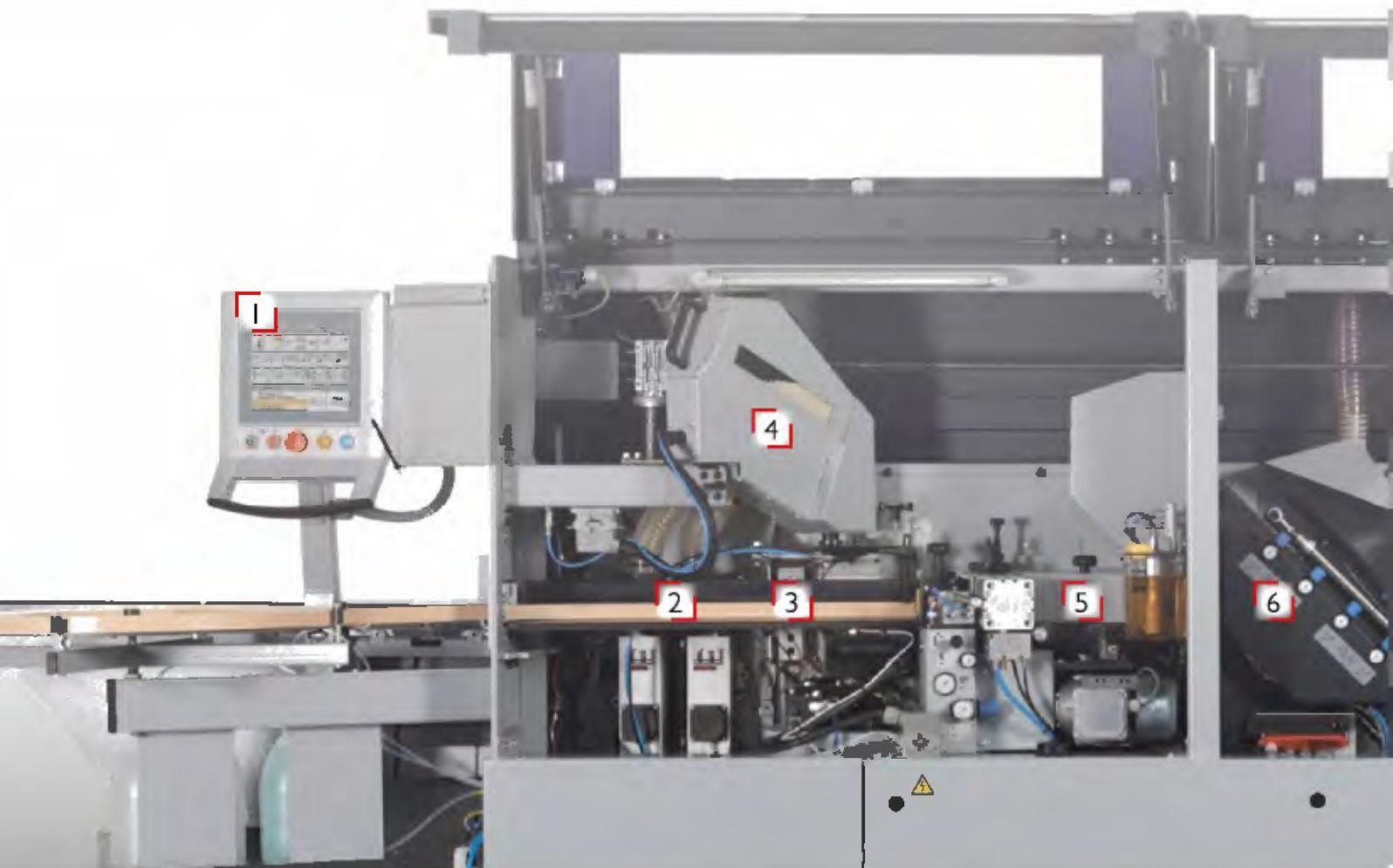

1 Control panel with 10.4" colour touch screen



2 Premilling unit with diamond milling cutters



3 Edge feed for coiled and strip magazines and guillotine scissors



5 Pressure unit with a pressure roller and 2 conical post-pressure rollers



6 End trimming unit with 2 independent saw units



7 Multifunctional trimming unit

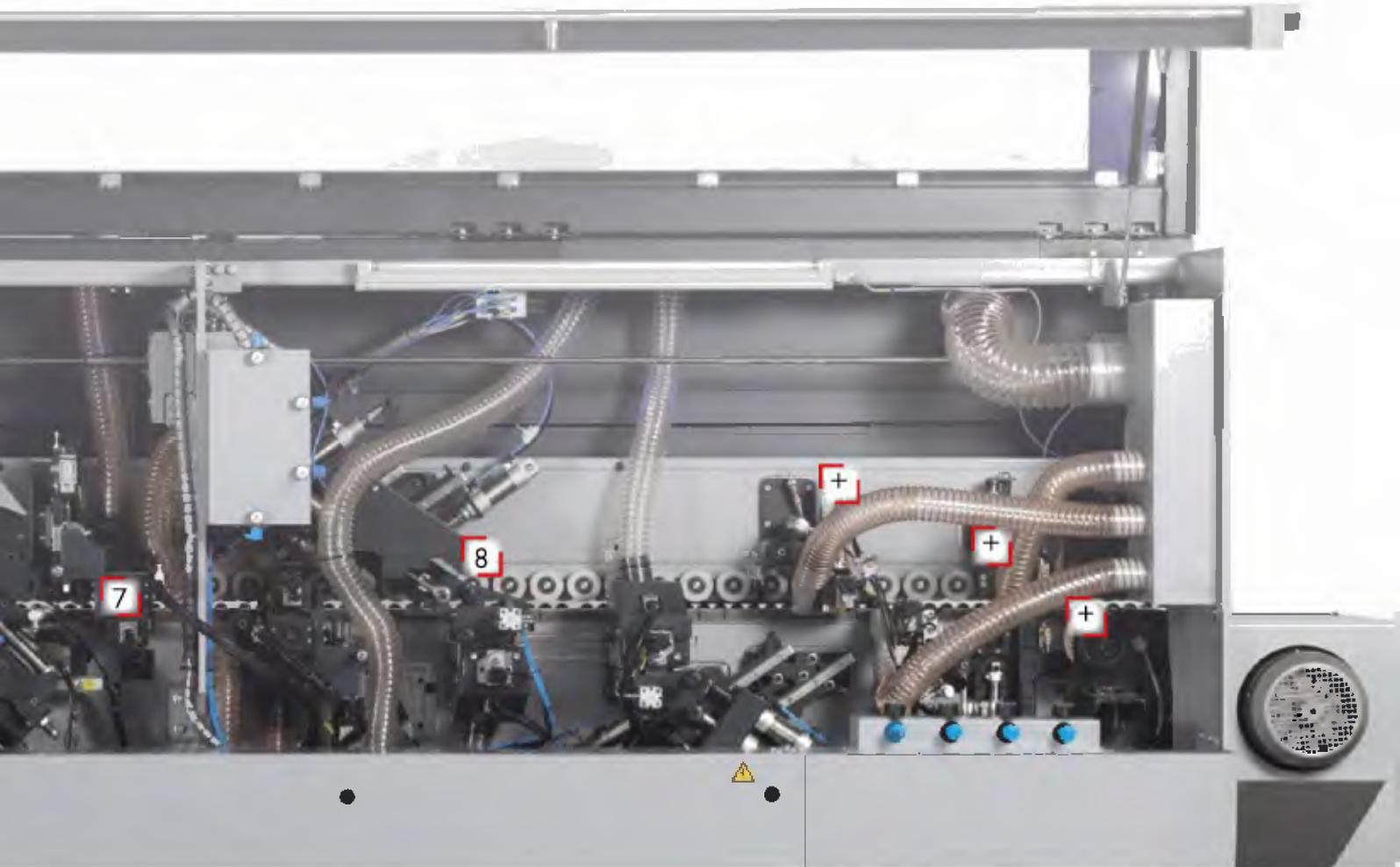

4 Gluepot with optional premelter



0 Option: Airmotion (on the back of the machine)



0 Option: Grooving unit (not shown in overview)



8 Corner rounding unit (Option: 2 motor corner rounding unit)

Finishing aggregates

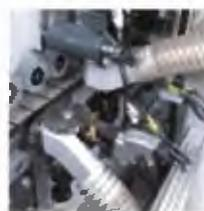

+ Radius scraping unit



+ Flush scraping unit



+ Buffing unit

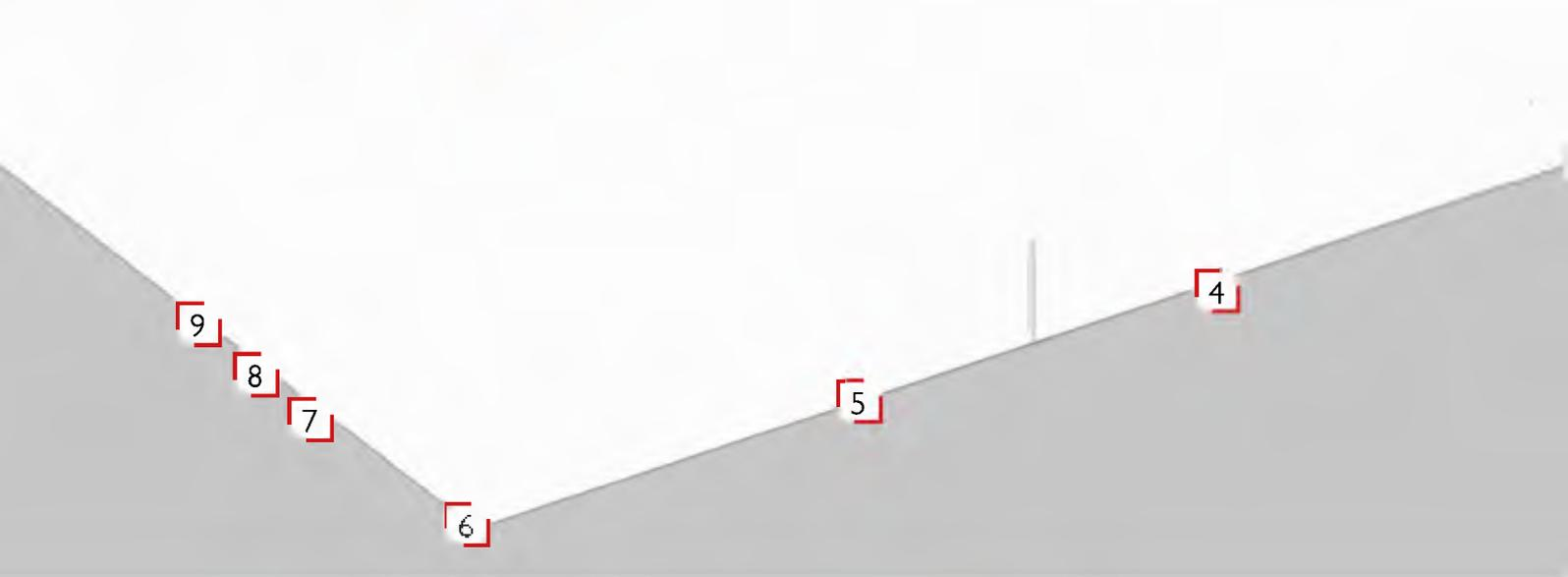

1 Premilling unit



- Counter rotating, activation controlled unit
- Equipped with either 49 mm or 64 mm milling cutters
- Spiral milling cutters (D = 80 mm) as standard
- Diamond tipped milling cutters
- Depth of cut 0-3 mm
- Both premilling units are controlled individually
- Guaranteed absolutely tear out free edges
- Precise formatting is possible

2 Gluepot



- Gluepot is positioned below the edge level, this ensures that glue cannot leak
- Appro. l. 500 mm can be processed on 19 mm boards
- Only 8 min warm-up time
- Teflon coated glue roller
- Glue applied using a glue roller for an even application
- Teflon coating ensures simple cleaning
- Temperature adjustment using the operating panel - Standby times
- Tool free quick-change system EVA & PUR

3 Edge feed



- Synchronised feed
- Strip magazine
- IR sensor for the edge feed
- Traffic light system for distance display
- Levelling options for the entire edge feed
- Improved edge feeding with more accurate settings
- Pendular shears offer a higher cutting performance when processing harder edge material

4 End trimming unit

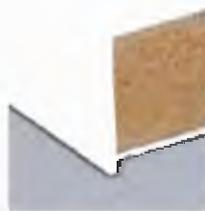

- Horizontal and vertical movement with two independent saw units
- 2 motors (12,000 rpm) equipped with 2 conical saw blades
- Can be adjusted 0°-15° from the control panel or manually

5 Multifunction trimming unit



- Flush, bevel and radius trimming
- 2 motors (12,000 rpm) for an optimal finish
- Absolute flush trim finish without any post processing required
- 2 motor position controlled axes with fine-adjustment controlled from the control panel
- Linear guides ensure exact precision
- Repeatability
- Simple adjustment
- Option:
Multiple copy rollers

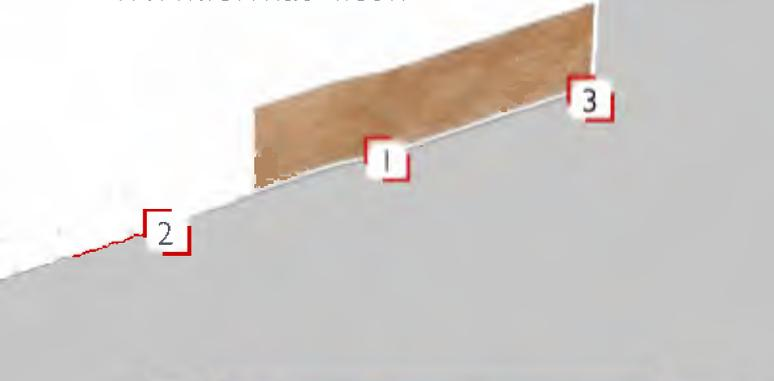

All processing possibilities at a glance!

On the example piece depicted, you can see all of the edge banding results that can be achieved with the available aggregates for this machine.



Control panel and controls

- 10.4" colour monitor with touch screen control
- Activation of the aggregates (x-motion/ e-motion)
- Aggregate adjustment with an increment of 0.01mm
- Visual display of the aggregates
- User-defined software
- Unlimited program storage
- Maintenance software - Information messages to the customer
- Standard: Record of the running metres

6 Single motor corner rounding unit

- Right-angled edges
- Post and softforming profiles
- 1 motor running at 12,000rpm for an optimal finish
- Processing height up to a max. 45 mm
- Oil damper guarantees that the aggregate is vibration-free and stops quickly
- This aggregate is controlled from the control panel
- Equipped with linear guides & diamond cutters with centrifugal clutch



7 Radius scraper

- Pneumatic activation from the control panel
- Scrapes off an extremely thin scraping (ca. 1/10mm) from the radius and removes any chatter marks
- Motor positioning of the edge thickness, horizontal fine-adjustment

6 Two motor corner rounding unit (only with the tempora 60.12)

- Right-angled edges
- Post and softforming Profiles 1 motor running at 12,000rpm for an optimal finish
- 2 independently operating units
- 1st unit processes the ends of the panel (front and back) and the corners on the upper side of the panel
- 2nd unit processes the ends of the panel and the corners on the lower side of the panel
- This split ensures flexible activation points of the sides to be processed
- When using both units a workpiece with a thickness of 60 mm max. can be processed



8 Glue scraping unit

- To remove the fine chatter marks for an absolutely smooth edge result
- Height adjustment using the feed height adjustment
- Pneumatic positioning of the unit
- This unit is activation controlled, activation and setting the starting point is carried out using the control panel



9 Buffing unit

- Polishing agent for glue free workpiece surfaces without wiping
- This unit can be equipped in combination with a cleaning agent spraying unit

Packages

Many customers find it a challenge to decide which individual units, processing possibilities and which equipment their future machine should have. For this reason, we offer unique customer orientated packages on the tempora series, which meet the general requirements of the majority of our customers.

Working closely together with woodworkers, we have gathered experience and information and implemented it. This then makes it possible to meet the requirements of the customer professionally and above all quickly.



tempora 60.08 x-motion plus



tempora 60.12 x-motion plus & e-motion*

Professional package

- Pneumatic/mechanic barrier prevents a premature feeding of a panel into the machine
- Premillers with replaceable cutters 64 mm in height instead of 49 mm
- Reverse function for the glue applicator roller
- Corner rounding unit for soft and postforming workpieces for the processing of the ends of the panel with 0.4–3.0 mm thick edge material and 10–45 mm workpiece height
- "e-motion" end trimming saw unit with 2 independent motors each with 0.37 kW, 12,000 rpm, tilted pneumatically 0°–15°
- I axis motor positioned radius scraping unit (height manually adjustable) incl. pneumatic disengage function
- Flush scraping unit, pneumatically controlled, upgrade to nesting is possible
- LED lighting

Professional package

- Pneumatic/mechanic barrier prevents a premature feeding of a panel into the machine
- Premillers with replaceable cutters 64 mm in height instead of 49 mm
- Reverse function for the glue applicator roller
- Corner rounding unit for soft and postforming workpieces for the processing of the ends of the panel with 0.4–3.0 mm thick edge material and 10–60 mm workpiece height
- Motorised adjustment and positioning of the corner rounding cutters
- Flush scraping unit, pneumatically controlled, upgrade to nesting is possible
- Spraying unit for cleaning agent before buffing unit
- LED lighting



tempora 60.12 x-motion plus & e-motion*



tempora 60.12 x-motion plus & e-motion*

Performance package 1 & 2

- Chain feed with 12 and 20 m/min feed speed and rubber covered pads for optimum grip of the workpiece
- Preparation for retrofitting of a premelter
- Pneumatic/mechanic barrier prevents a premature feeding of a panel into the machine
- Corner rounding unit for soft and postforming workpieces for the processing of the ends of the panel with 0.4–3.0 mm thick edge material and 10–60 mm workpiece height (additional with the **Performance Package 2**: 2 independent motors for the processing of the end and length, motorised positioning of the corner rounding unit instead of the corner rounding unit with 1 motor)
- Motorised adjustment and positioning of the corner rounding cutters
- Premillers with replaceable cutters 64 mm in height instead of 49 mm
- Reverse function for the glue applicator roller
- Flush scraping unit, pneumatically controlled, upgrade to nesting is possible
- LED lighting
- Spraying unit of releasing agent on the machine infeed side (PUR glue)
- Spraying unit for lubrication agent
- Spraying unit for cleaning agent before buffing unit

Complete package

- Chain feed with 12 and 20 m/min feed speed and rubber covered pads for optimum grip of the workpiece
- Preparation for retrofitting of a premelter
- Pneumatic/mechanic barrier prevents a premature feeding of a panel into the machine
- Corner rounding unit for soft and postforming workpieces for the processing of the ends of the panel with 0.4–3.0 mm thick edge material and 10–60 mm workpiece height
- Motorised adjustment and positioning of the corner rounding cutters
- Premillers with replaceable cutters 64 mm in height instead of 49 mm
- Reverse function for the glue applicator roller
- Flush scraping unit, pneumatically controlled, upgrade to nesting is possible
- LED lighting
- Spraying unit of releasing agent on the machine infeed side (PUR glue)
- Spraying unit for lubrication agent
- Spraying unit for cleaning agent before buffing unit
- Grooving unit for horizontal or vertical processing, motorised adjustment X+Y axis, limitation on the corner rounding unit 10–45mm workpiece height

*The x-motion plus and the e-motion packages vary slightly.
Your sales advisor would be happy to provide you with more details.

Technical specifications



	tempora 60.08 x-motion plus	tempora 60.12 x-motion plus	tempora 60.12 e-motion
Max. workpiece height	60 mm	60 mm	60 mm
Max. tape thickness	8 mm	12 mm	12 mm
Control panel with 10.4" colour touch screen	S	O	S
Manually adjustable pressure bar	S	S	-
Electrically adjustable pressure bar	-	-	S
Infrared heating lamp to heat up the panel edges	O	O	O
Reverse rotation function of the glue application roller	O	O	O
Working height	890 mm	890 mm	890 mm
Length [L]	4,590 mm	5,290 mm	5,290 mm
Width [W]	1,300 mm	1,300 mm	1,300 mm
Weight (depending on equipment, without packaging)	1,500 kg	1,500 kg	1,770 kg
Extraction connection Ø	120/6 x 60 mm	120/7 x 60 mm	120/7 x 60 mm
Feed speed	12 m/min.	12 & 20 m/min.	12 & 20 m/min.
Min. workpiece length	140 mm	140 mm	140 mm

S ... Standard equipment O ... Option - ... not available



Further information about the technical data, individual configuration options and all noise level values can be found on the internet at www.format-4.com

Space requirement

Scale
1:50

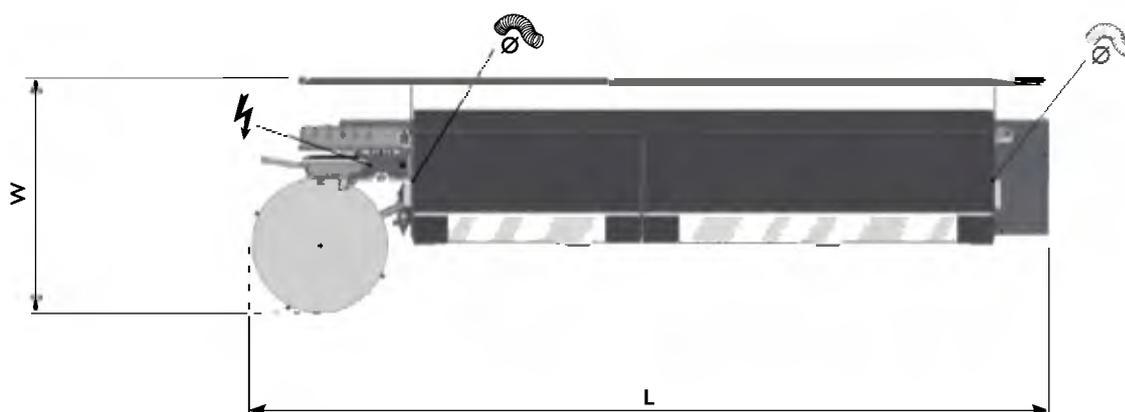

Symbolic image tempora 60.08 x-motion plus,
tempora 60.12 x-motion plus, tempora 60.12 e-motion

Return systems

Production maximisation
for single person operation -
also for your workshop



U-motion

FORMAT

U-motion classic
return system
U-motion professional

The new edgebander return systems bring production maximisation for single person operation into every workshop:

The adjustable feed speed of the material-friendly conveyor belt ensures a constant material flow, free from interruption with minimum distance between the workpieces. Regardless of whether it is equipped with a transverse conveyor or a rotatable head, the impressive rate of 14 workpieces per minute ensures that optimum efficiency is guaranteed and you maximise the production output of your edgebander.



Your advantages at a glance:

- > Maximum productivity and reduced production costs with single person loading
- > The healthy workshop: Fatigue-free working, puts no strain on your back - fewer sick days
- > Perfect handling of materials - no more scratches!
- > Numerous configuration options make it individually configurable

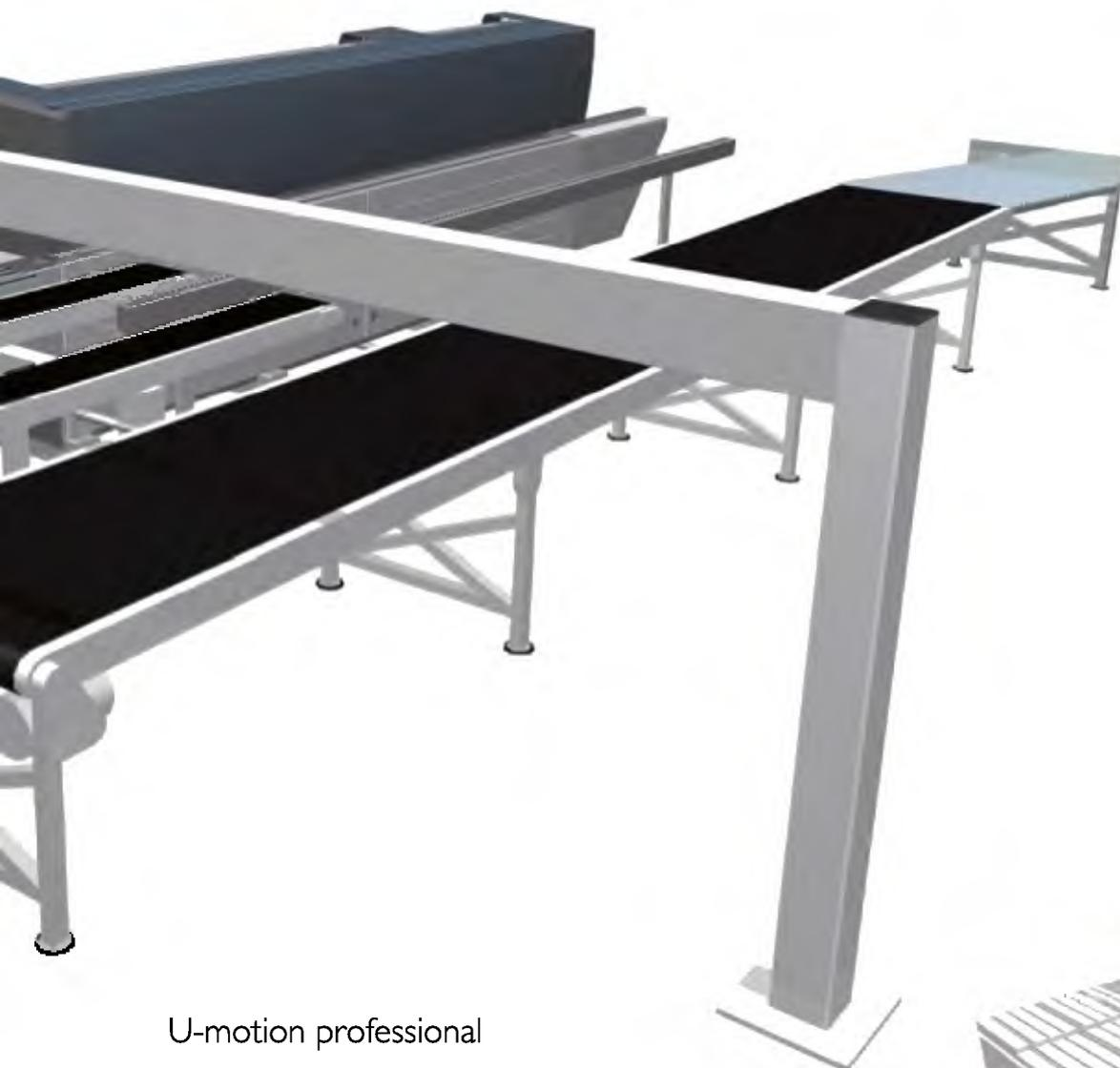

U-motion professional



U-motion classic

Technical specifications



	U-motion classic	U-motion professional
Length of cycle	14 parts/minute	14 parts/minute
max. panel size	2,800 x 1,300 mm	3,000 x 1,500 mm
Max. load	60 kg	60 kg

\$... Standard equipment O ... Option - ... not available



Further information about the technical data, individual configuration options and all noise level values can be found on the internet at www.format-4.com

Space requirement

Scale
1:75

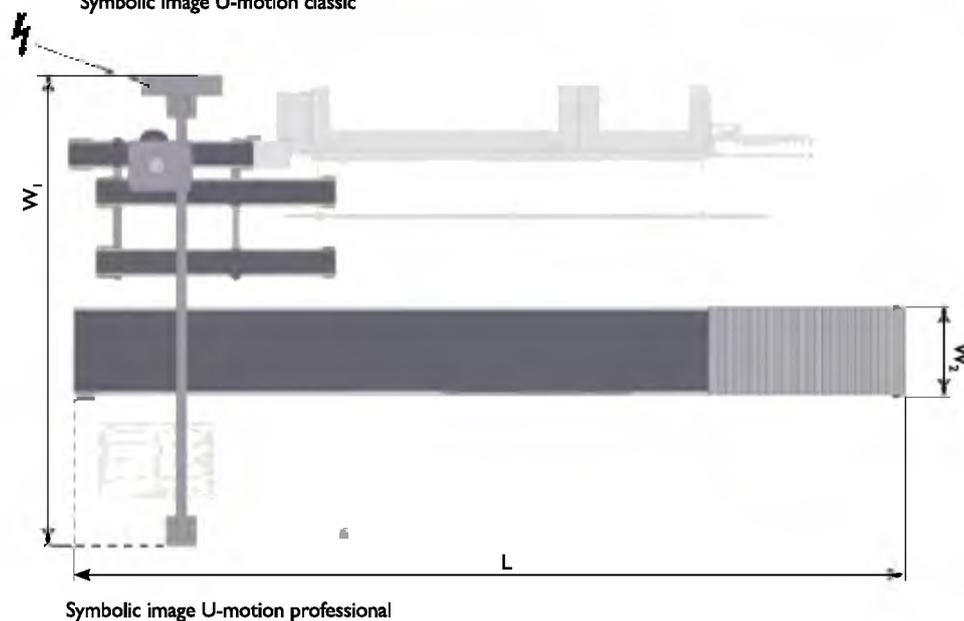
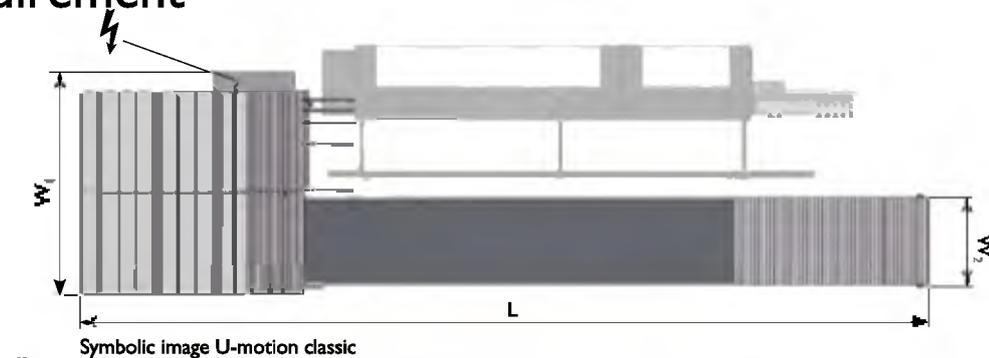

Dimensions given can vary if special options are selected

The resulting setup dimensions of the Format-4 U-motion return system varies depending on the type of machine and the dimensions of the workpiece to be processed. Your sales advisor would be happy to provide you with more details.

finish

The first choice, when the "finish" of your workpiece surface must be better than perfect



finish 1302
finish 1102



For results that impress

Format-4 wide belt sanders are sturdily built, incorporate the latest technology and guarantee maximum productivity. The choice is yours: 1,100 mm or 1,300 mm working width, different sanding aggregates and aggregate combinations and much more. With premium quality, absolute precision and maximum operating comfort a perfect finish is guaranteed regardless of the challenge.



finish 1102



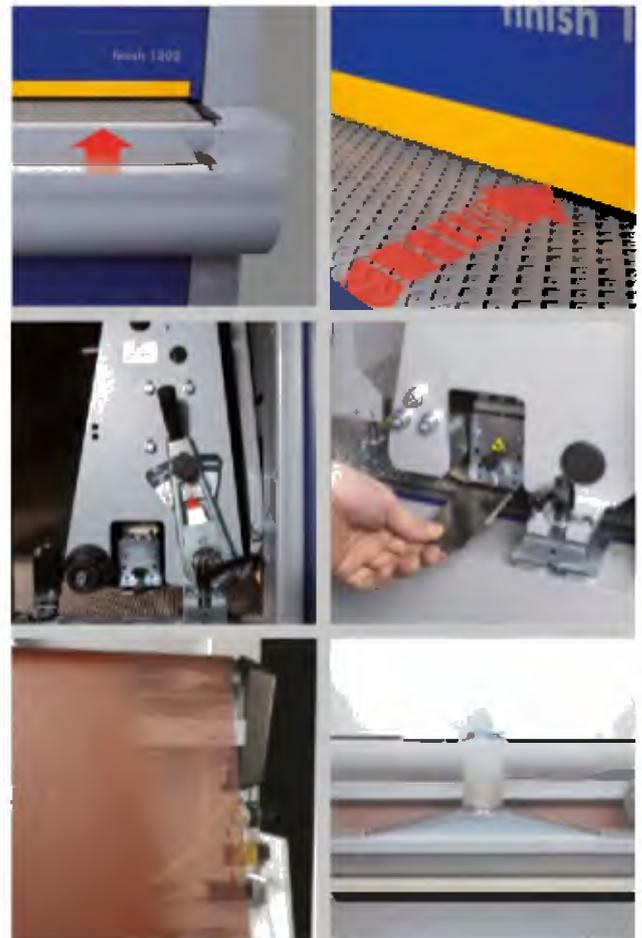

Sanding height
3–170 mm

Continuous feed belt
for maximum
durability

Simple adjustment
of the aggregates

Sanding pad for fine
sanding including
quick change system

Sanding belt guidance
with a modular
light beam

Brushing unit

Aggregates

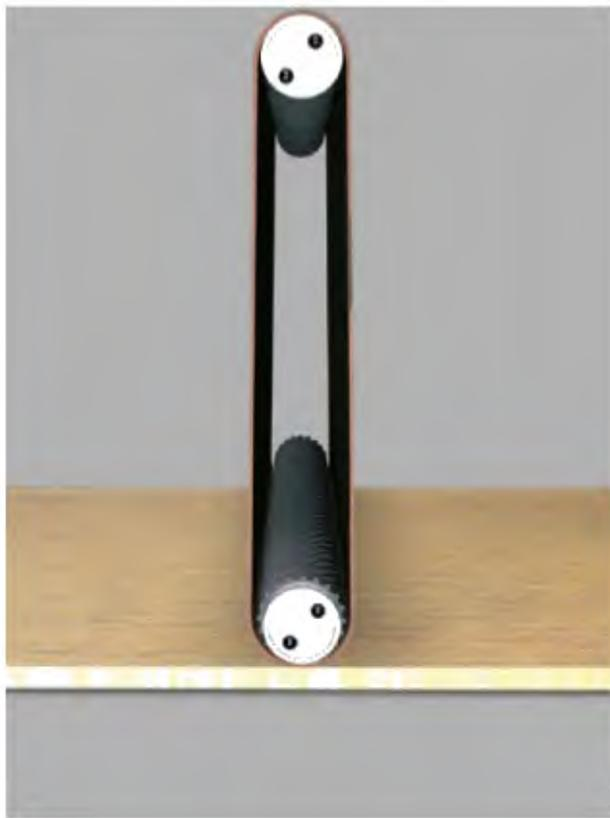

Contact roller aggregate

The profiled contact roller (with 85° shore) guarantees precision without compromise when calibrating. Contact rollers optionally available in steel. With its flexible grit compensation, the roller can be adjusted to any position for the exact grit size.



Combination aggregate with sanding pad

The aggregate is a combination of the rubber contact rollers and a sanding pad. The profiled contact roller (also available in steel) guarantees maximum precision when calibrating. With its flexible grit compensation, the roller can be adjusted to any position for the precise sanding belt thickness. A contact free optical sensor controls the sanding belt oscillation ensuring an optimal centralisation and maximum operating smoothness.

Control

Control panels 1100/1300

The clearly structured and intuitive control panel provides maximum user comfort and maximum productivity. The machine functions that are available are shown graphically and operated using a high quality switch. The infeed thickness is clearly shown on the digital display and by using the push button can be adjusted with an accuracy of a tenth of a millimetre.

The machine can be equipped with a touch screen control either as an option or as standard with the segmented sanding pad. All of the settings can be carried out intuitively and comfortably from the centrally located control panel. Using the touch screen control panel the parameters can be saved as a program and loaded whenever they are required, ensuring maximum process reliability.



Sanding pads

Electro-pneumatic sanding pad (EP) for fine and veneer sanding

The electro-pneumatic sanding pad (EP) distributes pressure uniformly over the whole surface and adapts itself to the surface. Surface tolerances are balanced out. The pneumatic engage/disengage function prevents sanding through the veneer and also the front as well as the rear side of the workpiece.

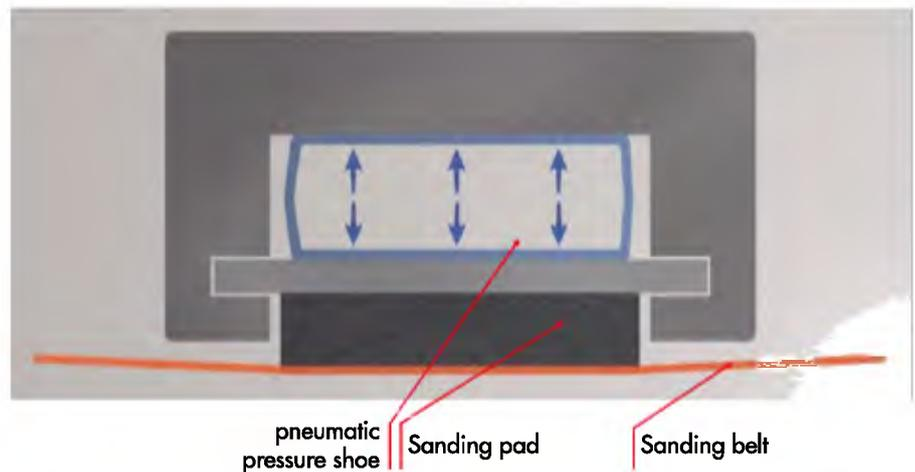

Segmented electro-pneumatic sanding pad

The segmented, electro-pneumatic sanding pad is used especially for lacquer sanding with a semi gloss finish and for workpieces with round or acute-angled design. The subdivision of the pressure bar into individual parts as well as the touch screen control of the engage/disengaging points and segments, enable the exact definition of the sanding area. Using the touch screen control panel the parameters can be saved as a program and loaded whenever they are required, ensuring maximum process reliability.

Options

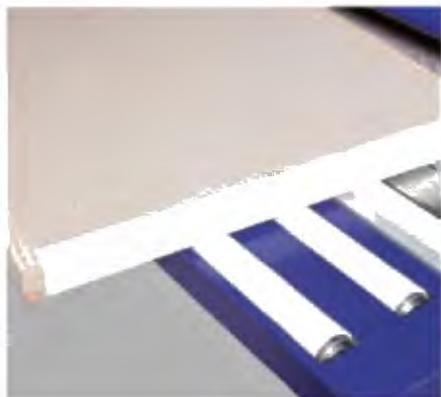

Infeed and outfeed roller table

As an option, we are able to equip your Format-4 wide belt sander with roller extension tables both on the infeed and outfeed side.

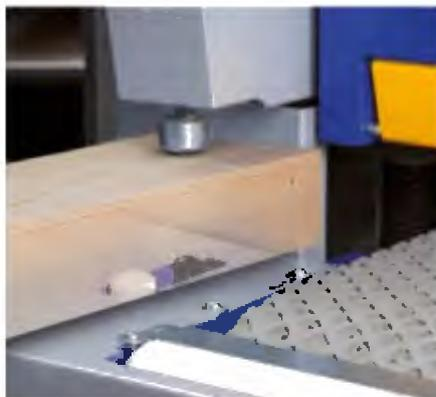

Thickness measurement

Automatic thickness measurement facilitates adjustment of the machine to the desired workpiece thickness. The workpiece is measured directly on the machine without additional measuring devices being required. The required sanding depth can be set in + or - using the adjustment wheel.



Pneumatic selection of the contact rollers

This option makes it possible to switch the contact rollers on/off from the control panel. Together with the storable programs, the flexible use of the machine is made considerably easier.

Technical specifications



	finish 1102	finish 1302
Sanding belt motor	11 kW (15 HP)	11 kW (15 HP)
Motor frequency	50/60 Hz	50/60 Hz
Ammeter for aggregate load monitoring	S	S
Sanding belt	1,110 x 2,200 mm	1,310 x 2,200 mm
Vacuum table with fan	4.5 kW	4.5 kW
Roller table extensions for workpiece feed	300 mm	300 mm
Variable feed speed adjustment inverter	2.8–20 m/min	2.8–20 m/min
Working height	780–893 mm	780–893 mm
Length [L]	1,604 mm	1,804 mm
Width [W]	2,232 mm	2,232 mm
Weight (depending on equipment, without packaging)	2,150 kg	2,350 kg
Extraction connection (without additional equipment)	2x 160 mm	2x 200 mm

S ... Standard

Space requirement

Scale
1:50

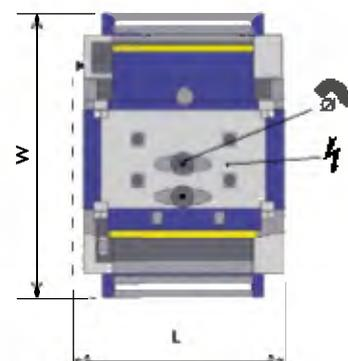

Symbolic image finish 1102, finish 1302



Further information about the technical data, individual configuration options and all noise level values can be found on the internet at www.format-4.com

Dimensions given can vary if special options are selected

Intermediate lacquer sanding (finish 1102/1302, finish 1350 classic/classic gloss)



Segmented sanding pad

The segmented, electro-pneumatic sanding pad is used especially for lacquer sanding with a semi gloss finish and for workpieces with round or acute-angled design.



Variable feed speed adjustment

Optionally the feed speed can be variably adjusted and set between 3.7–16m/min.



Cleaning air jets

The cooling and cleaning air jets extend the life of the sanding belt. The operation control ensures economical use of the compressed air.

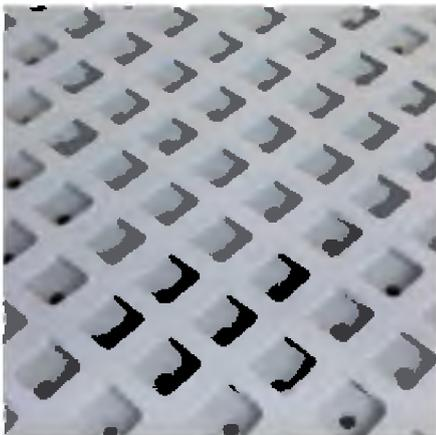

Vacuum table

The optional vacuum table makes it possible for small or smooth workpieces to be processed.



Variable sanding belt speed

The sanding belt speed can be adjusted from 2.4–19 m/sec to suit different surfaces.

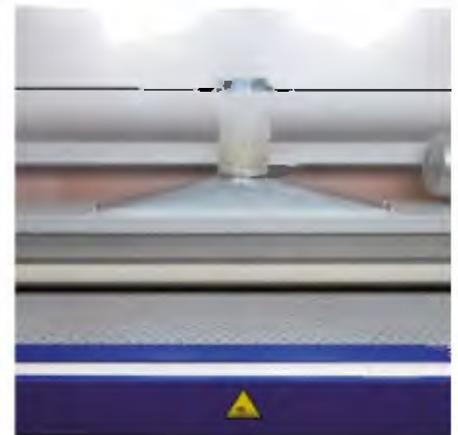

Brushing unit

The brushing unit mounted on the outfeed side can be fitted with a wide range of brushes. The workpieces can be cleaned, polished or structured depending on the type of brush.

finish 1350 classic



For a more than convincing finish

Solid design, high quality system components and perfect results - The premium model series "finish" will now be expanded to include two additional wide belt sanders: "finish 1350 classic" and "finish 1350 classic gloss". The new machines convince with maximum processing dimensions combined with the brand new super finish unit with chevron belt and electro-pneumatic segmented sanding pad as well as touch screen control.





Fixed feeding table
at 900 mm

Simple adjustment
of the aggregates

Cross sanding
aggregate for a high
gloss finish

Sanding belt guidance
with a modular
light beam

Brushing unit

Table extension



finish 1350 classic gloss

Aggregates



Contact roller aggregate

Contact roller aggregate with rubber contact roller (55 shore) for fine sanding work. Motorised grain compensation control from the operating panel.



Combination super finish aggregate

In addition to the contact roller, the combination super finish aggregate also has a sanding cushion with a felt glide coating (chevron belt). This glide belt applies an even softer sanding pressure on the workpiece and is used predominantly for the sanding of lacquered workpieces and for high-gloss materials. The completely uniform pressure, levels out all oscillation marks and guarantees a homogenous sanding result. The super finish aggregate has a segmented electro-pneumatic sanding pad included. Excellent sanding results are guaranteed even when processing round or angled workpieces.



Cross belt sanding aggregate for a high gloss finish

The cross belt sanding aggregate equipped with an electro-pneumatic sanding pad and chevron belt as standard is particularly suited for the processing of lacquered surfaces and high gloss production. Rough wood fibres that cross the grain are removed by the sanding belt and the subsequent wide belt then smoothes the surface. The cross sanding direction ensures that there are considerably less wood fibres and a noticeably smoother end result is achieved.

Feed table



The feed speed can be continuously adjusted from the control panel between 2.8–20 m/min as standard.

Control

Control panel

The clearly structured and intuitive control panel provides maximum comfort and maximum productivity. The machine functions that are available are shown graphically and controlled using high quality switches. The infeed thickness is clearly shown on the digital display and can be adjusted to an accuracy of a tenth of a millimetre by using the push button.



Options

Table extensions

The table extensions improve the angle at which workpieces are fed into the machine and also make it easier to work



Brushing unit

An optional workpiece brushing unit is possible on the outfeed side of the machine.

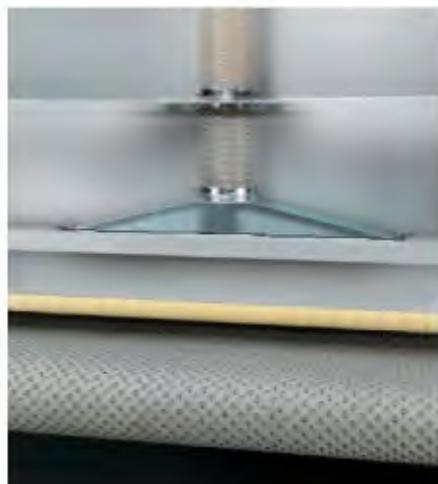

Cleaning/structuring brushes

Different brush types can be used for cleaning, polishing or structuring.

Technical specifications



	finish 1350 classic	finish 1350 classic gloss
Sanding belt motor	11/15 kW	11/15 kW
Motor frequency	50/60 Hz	50/60 Hz
Ammeter for aggregate load monitoring	S	S
Sanding belt	1,370 x 2,200 mm	1,370 x 2,200 mm
Vacuum table with fan	4.5 kW	4.5 kW
Roller table extension for workpiece infeed	300/900 mm	300/900 mm
Variable feed speed adjustment inverter	2.8–20 m/min	2.8–20 m/min
Working height	900 mm	900 mm
Length [L]	2,200 mm	2,200 mm
Width [W]	2,100 mm	2,100 mm
Weight (depending on equipment, without packaging)	2,350 kg	2,350 kg
Extraction connection (without additional equipment)	2x 200 mm	2x 200 mm

S ... Standard



Further information about the technical data, individual configuration options and all noise level values can be found on the internet at www.format-4.com

Space requirement

Scale
1:50

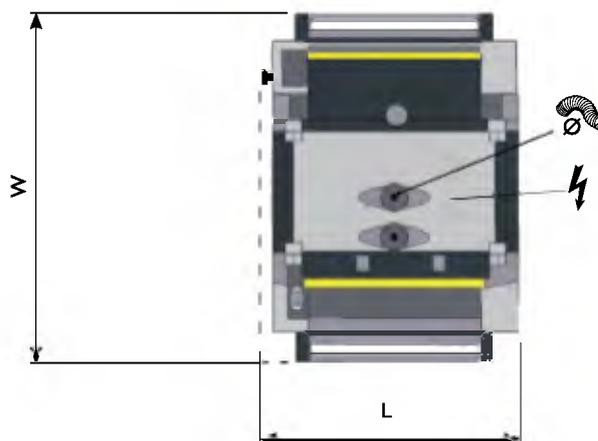

Symbolic image finish 1350 classic, finish 1350 classic gloss

Dimensions given can vary if special options are selected



Beam saws

Precision, versatility
and productivity all in one

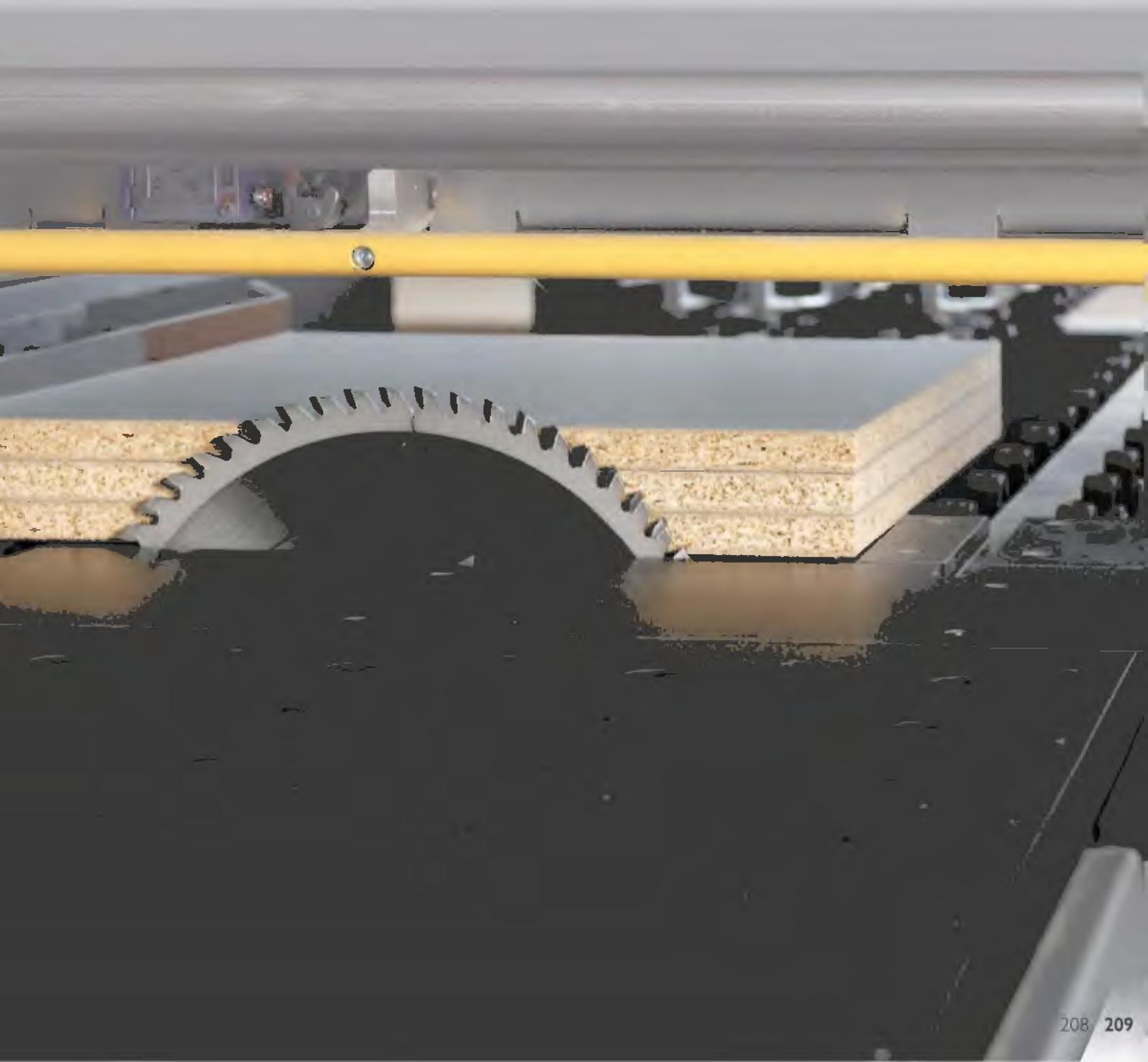

Kappa V60

FORMAT

Powerful, accurate and space saving

The vertical beam saw from Format-4 ensures a large increase in your productivity. The solid, single piece frame construction and a saw carriage running on steel rails guarantees cuts accurate to one tenth of a millimetre. A wide range of accessories that assist the user with improved handling and operation, are already included in the standard equipment of the machine.

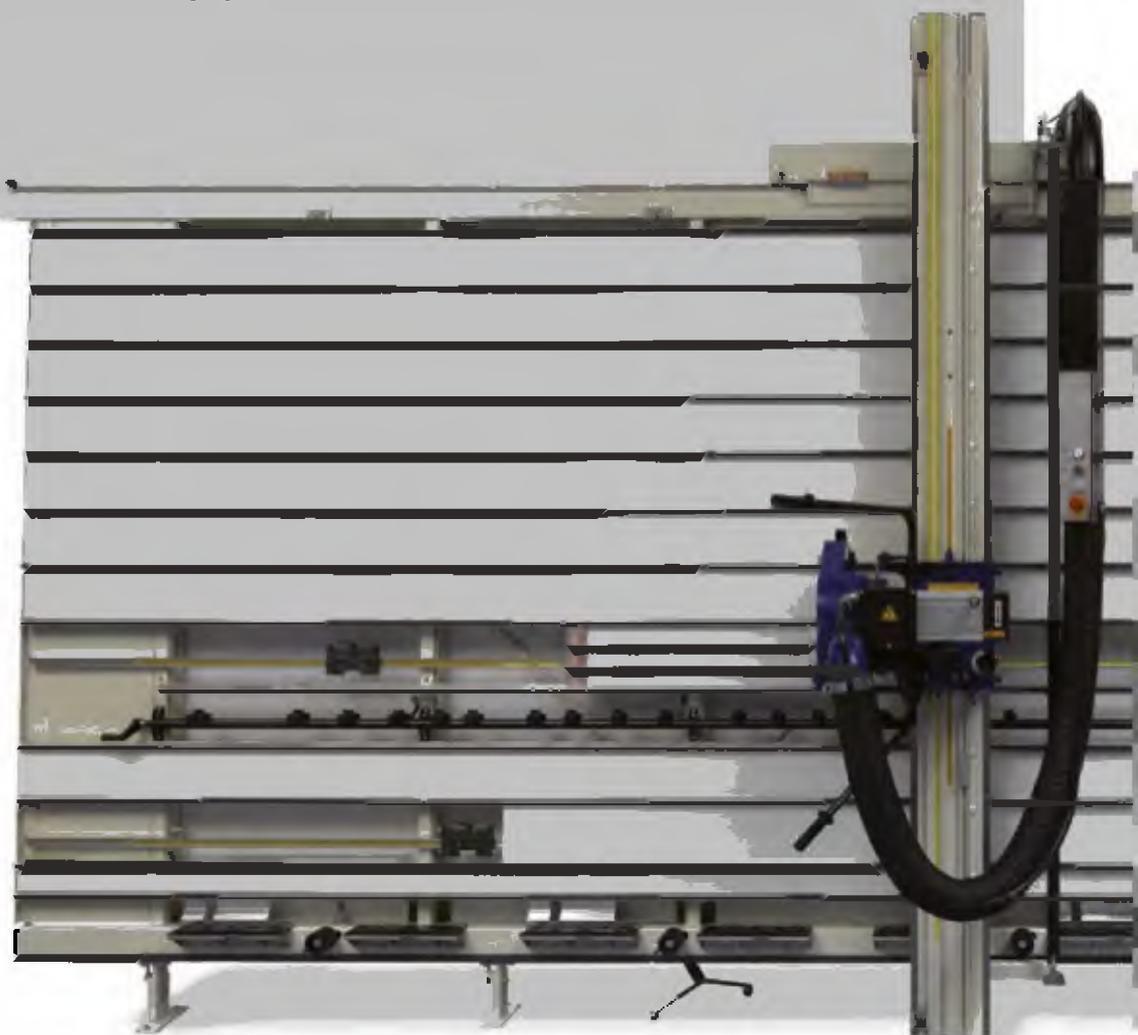

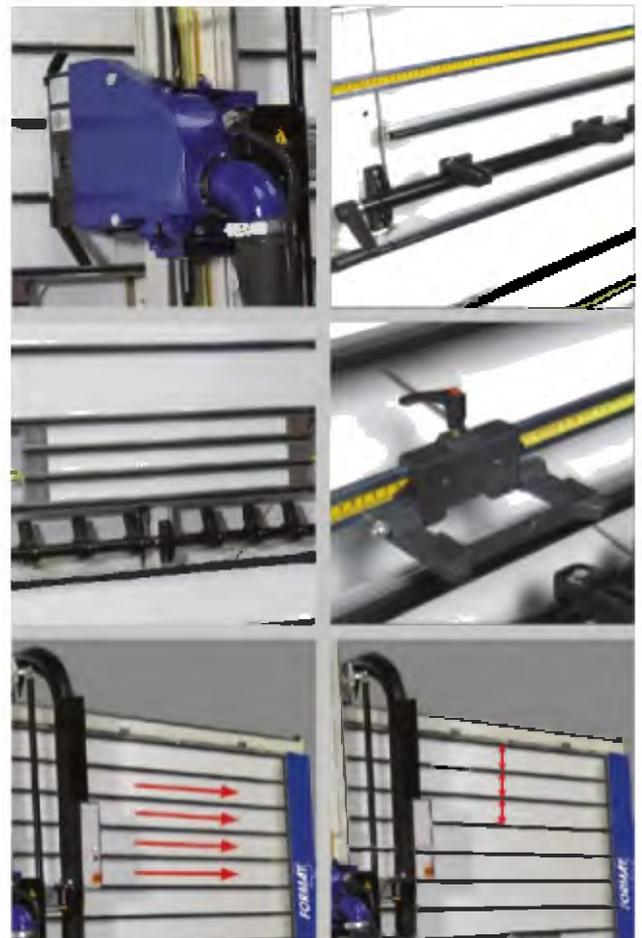

Saw unit,
precise cuts

Tilt away
centre support

Moveable aluminium
sliding carriages

Standard:
an extra fence

Integrated powerful
TRC dust extraction

Moveable rear wall,
evasive spacers



Saw unit

Guided along steel rails, enabling cuts accurate to 1/10 mm. Power 4 kW motor, saw blade diameter 250 mm (optionally with scoring unit) and 60 mm cutting depth.



Additional fence

An additional fence is included in the standard equipment for the crosscutting of narrow strips.



Centre support

The easy to swing away centre support covers the full machine length and can be split for small workpieces.



Small part support

Moveable aluminium sliding carriages: Quick and easy to position.



TRC dust extraction

Integrated, particularly powerful TRC dust extraction. Dust emissions considerably below 1 mg/m³.

Moveable rear wall

(Evasive spacers)

When cutting horizontally the spacers move vertically to avoid being damaged by the saw blade.

kappa automatic

FORMAT.

Redefining
productivity



Beam saws are first and foremost in the production process. The Format-4 kappa automatic beam saws guarantee the shortest cutting cycles combined with perfect cutting results. The modular based cutting optimisation program with barcode labelling for further processing, guarantees maximum process reliability. Upgrade options offer customer specific adaptation to individual working processes.



Saw carriage with main and scoring unit

Highly precise saw carriage drive

Perfect cutting results - new cutting direction

Ergonomic control panel with 24" screen

Maximum repeatability

Veneer fences if required



kappa automatic 80



kappa automatic 60

Chip free, precise cutting quality

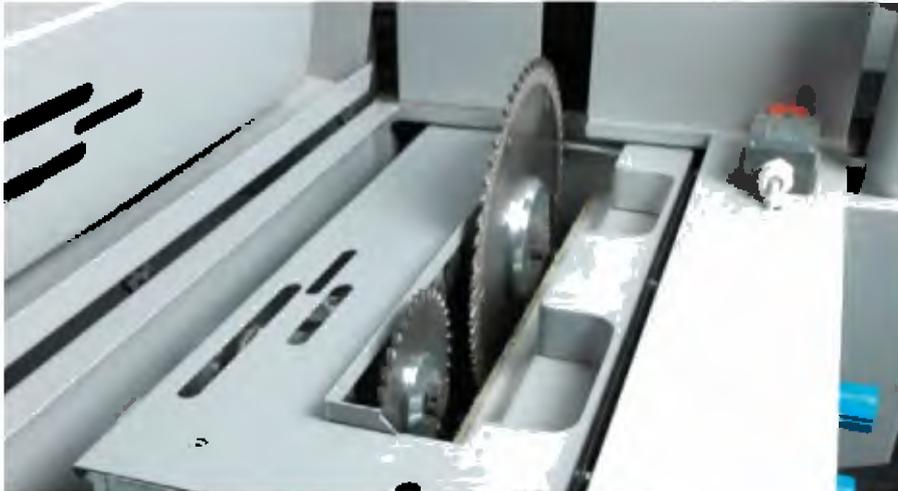

Saw carriage with main and scoring unit

The saw carriage with main blade and scoring blade running on ground and hardened round guides ensures an extremely smooth movement and an exact cutting angle. The cutting height can be adjusted manually, pneumatically or using electro-motors.

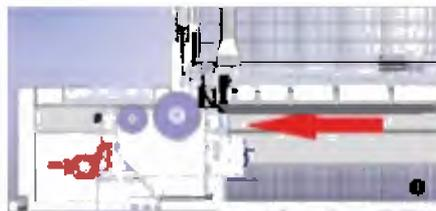
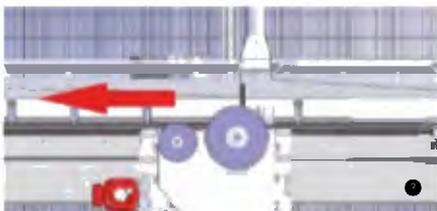
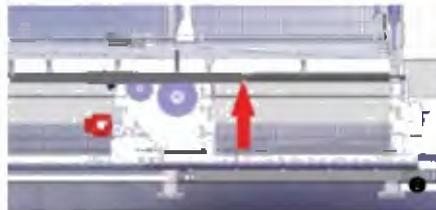
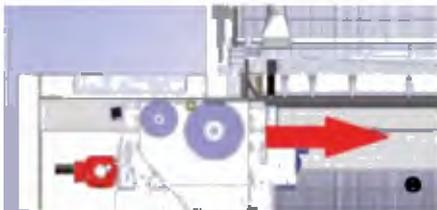

Cutting direction against the fence

The cutting direction against the fence ensures an exact 90° cut as the workpiece is pushed against the fence by the saw blade as it cuts.



Saw carriage drive

The constant speed of the saw carriage is variable and can be set between 5–100 m/min from the control panel. The rack and pinion system on which the carriage runs guarantees a constant cutting quality regardless of the material being processed.

Workpiece transport

Solid steel clamps, pneumatically controlled, guarantee a safe and damage-free clamping of panel stacks (opening height 80 mm) and individual small panels.

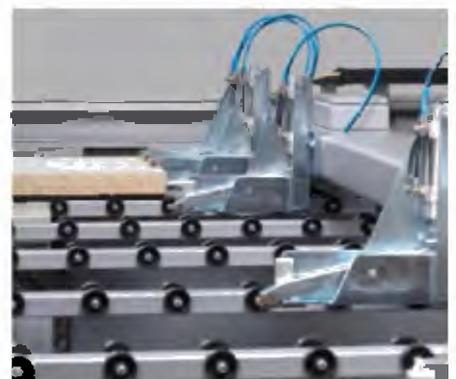
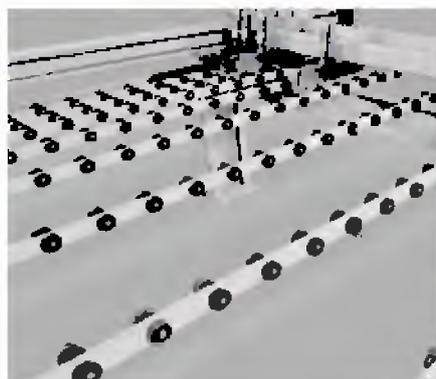

Short cutting cycles

Automatic cutting length recognition

A laser sensor on the saw carriage identifies the end of the panel and stops the carriage automatically once the cut is complete. The saw blade and scoring blade drop automatically below the level of the table and move back to the starting position. Cutting cycles are practically reduced to the time it takes to load and unload the material.

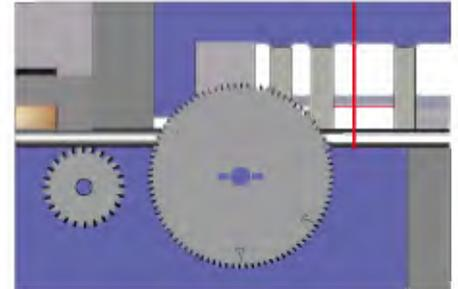
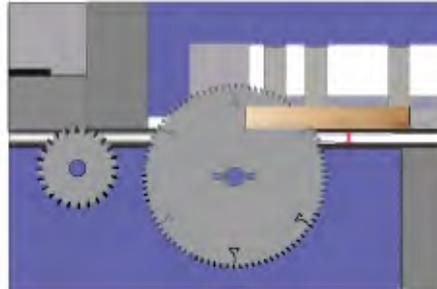

Cutting optimisation software

The modular cutting optimisation software uses the material list to calculate the most economic cutting process taking the cutting times and amount of waste into consideration. Compatible with the majority of construction and design programs it is also possible to calculate the amount of material and length of edge required, cutting times and/or be connected to a warehousing system with material administration.

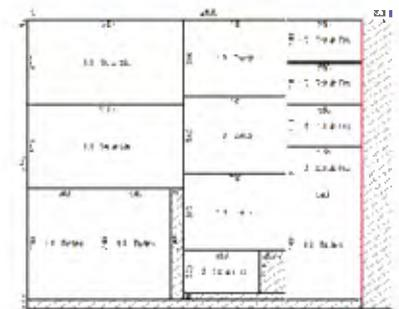

Effective loading using a lifting table/panel warehousing system

With the lifting table/panel warehousing system attached to the rear of the machine, it makes it possible to load the saw, panel by panel. The panels required can be loaded directly from the stack of panels onto the saw.



Cutting stacked panels

The saw blade projection of 55 or 80 mm in combination with a powerful drive unit offers the possibility to cut several stacked panels in one run which helps to increase production speed significantly.

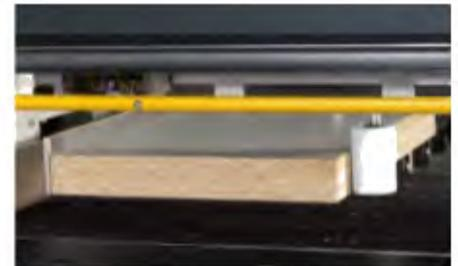

Pressure device

The pressure device with rollers presses the workpiece against the fence and guarantees an exact 90° angle (for workpiece widths 50–1,200 mm).

Simple operation

The simple design of the control panel and the clearly laid out menu guidance of the software control with a Windows based system, is intuitive in its operation. Connecting the machine control to existing systems or networks is of course possible. The kappa automatic can be equipped with Ardis cutting optimisation software. As an option, it can also be equipped with a label printer.



Maximum repeatability

Teilledaten Kopfzeile		Wert	
Produktname	1000x1000	Material	ALU 6063
Lot		Material	ALU 6063
Material		Material	ALU 6063
Lot		Material	ALU 6063

Teilledaten (1%)					
Los	Menge	Länge	Breite	Bezeichnung	Material
1	1	1000	1000	1000x1000	ALU 6063
2	1	1000	1000	1000x1000	ALU 6063
3	1	1000	1000	1000x1000	ALU 6063
4	1	1000	1000	1000x1000	ALU 6063



Double measuring system on the material pusher

The material positioning unit is equipped with two measuring systems that constantly monitor each other. The combination of a highly precise servomotor and solid material grips ensures maximum repeatability is achieved. The measuring system is separate to the drive system and is completely free from wear and tear.

Saved cutting plans

Cutting plans from previous projects can be saved and later recalled. By using the "multiplier" function, the workpiece can be reproduced as needed.

Perfect process reliability



Label

In combination with the cutting optimisation software a label can be printed for each workpiece with various information (order number, intended use, CNC program, which side is to be put through edgebander).

Safer product effect

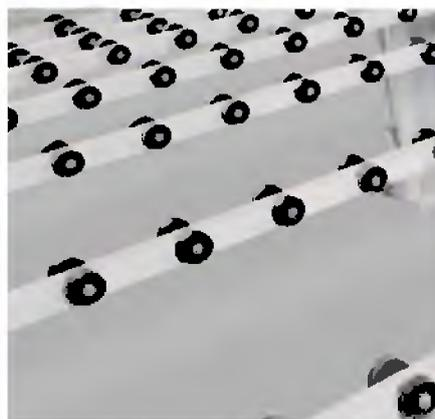
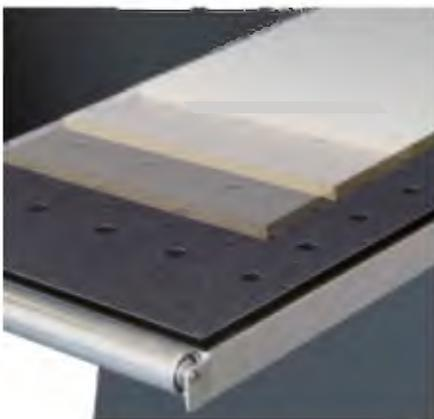

Material compatible handling

Unloading tables with air cushion technology guarantee a smooth handling of the material and a constant production flow especially when processing stacks of panels. Wheel conveyors situated around the material pusher ensure a gentle positioning of the material. For particularly pressure sensitive material the clamping pressure of the clamps can be adjusted using a manometer.

Flexibility

optimised additional equipment enables the perfect customisation to the customer specific manufacturing process.

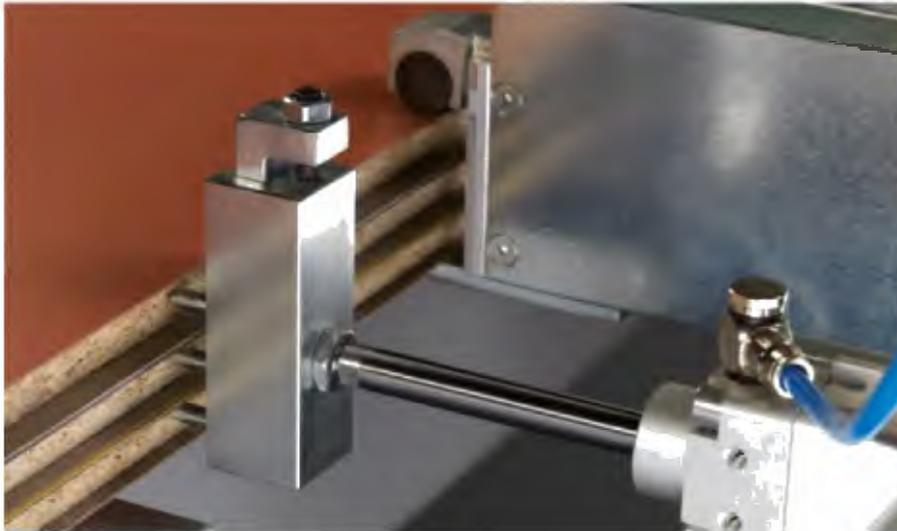

Veneer fences

Pneumatic veneer fences are available for cutting veneered panels which have a veneer projecting edge or laminated panels.

Electrical cutting height adjustment with groove function



Variable speed control of the main saw blade 2,000–6,000 rpm



Additional clamps

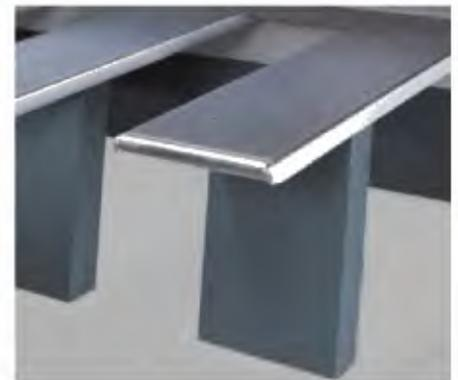

Additional unloading table

Technical specifications



	kappa automatic 60	kappa automatic 80	kappa automatic 100	kappa V60
Cutting length 3,200 mm	S	S	S	○
Cutting length 3,800 mm	-	-	○	-
Cutting length 4,300 mm	-	○	○	-
Cutting length 4,200 mm	-	-	-	S
Cutting length 5,300 mm	-	-	-	○
Cutting length 6,080 mm	-	-	-	○
5.5 PS (4.0 kW)	-	-	-	S
7.5 PS (5.5 kW)	S	-	-	-
12.0 PS (9 kW)	-	S	S	-
18.0 PS (13.5 kW)	-	○	○	-
Travelling distance of the material pusher	3,200 mm	3,200/4,300 mm	3,200/3,800/4,300 mm	-
Saw blade diameter	320 mm (protrusion) 60 mm	320 mm (protrusion) 80 mm	355 mm (protrusion) 100 mm	250 mm
Length [L]	5,430 mm	5,430–6,530 mm	5,430–6,530 mm	5,600 mm
Width [W]	6,607 mm	6,607–7,705 mm	6,607–7,705 mm	2,985 mm*
Weight (depending on equipment, without packaging)	4,800 kg	5,100 kg	5,950 kg	910 kg
Extraction connection Ø	100+100+100 mm	100+100+100 mm	100+100+100 mm	100+100 mm

S ... Standard equipment ○ ... Option - ... not available *without strip fence



Further information about the technical data, individual configuration options and all noise level values can be found on the internet at www.format-4.com

Space requirement

Scale

1:75

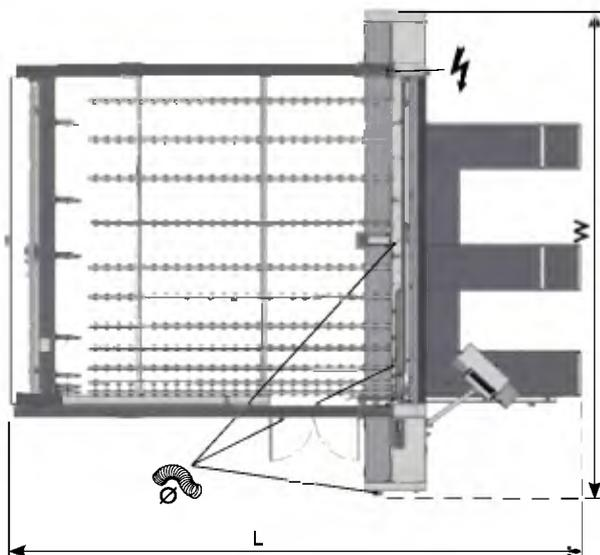

Symbolic image kappa automatic 60, kappa automatic 80, kappa automatic 100

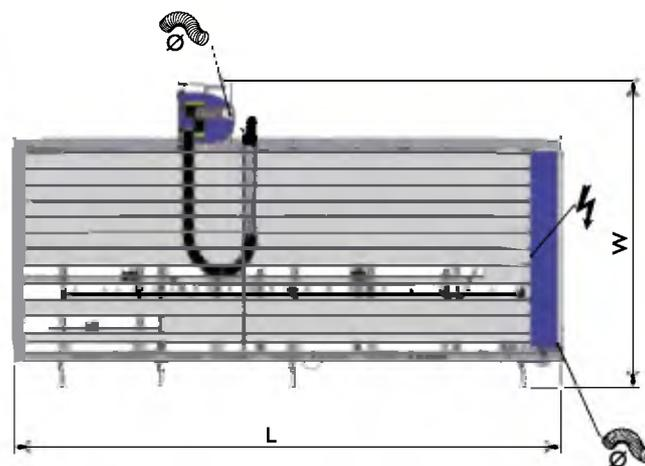

Symbolic image kappa V60

Dimensions given can vary if special options are selected

Vacuum panel lifter

The perfect unit for the quick and efficient transport of coated chipboard panels

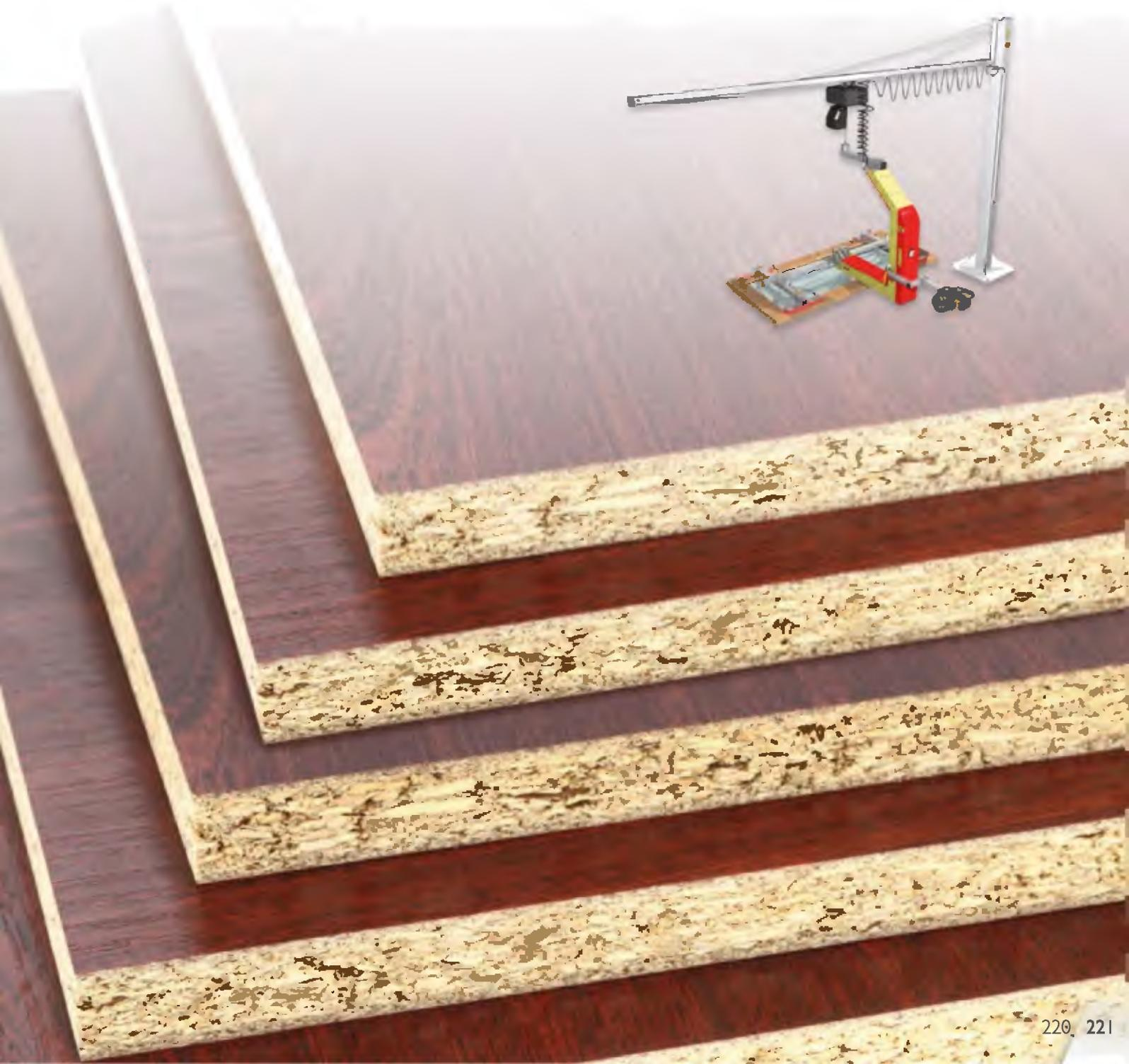

V-motion

FORMAT.

V-motion

Vacuum panel lifter

The large vacuum discs hold the panels of up to 150 kg in either a horizontal or vertical position leaving absolutely no marks. Using the vertical chain hoist, the panels can then be loaded safely onto the machine. Regardless of whether it is used as a crane system mounted to the workshop wall (or the workshop floor), or as a track system with a crane trolley (mounted from the ceiling or from a bridge structure free standing), the V-motion unit can be extended to a total length of up to 16 metres (track system) or 6 metres as a crane system.



Your advantages at a glance:

- > Maximum productivity and reduced production costs with single person loading
- > The healthy workshop: Fatigue-free working, puts no strain on your back - fewer sick days
- > Numerous configuration options make it individually configurable
- > Perfect handling of materials - no more scratches!

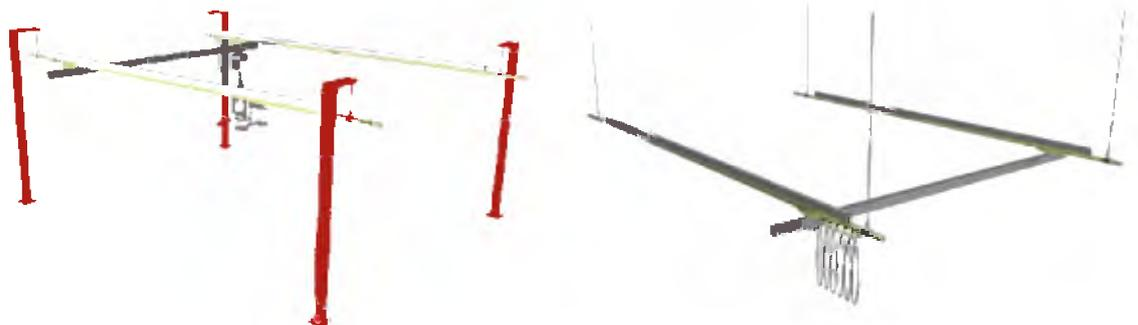
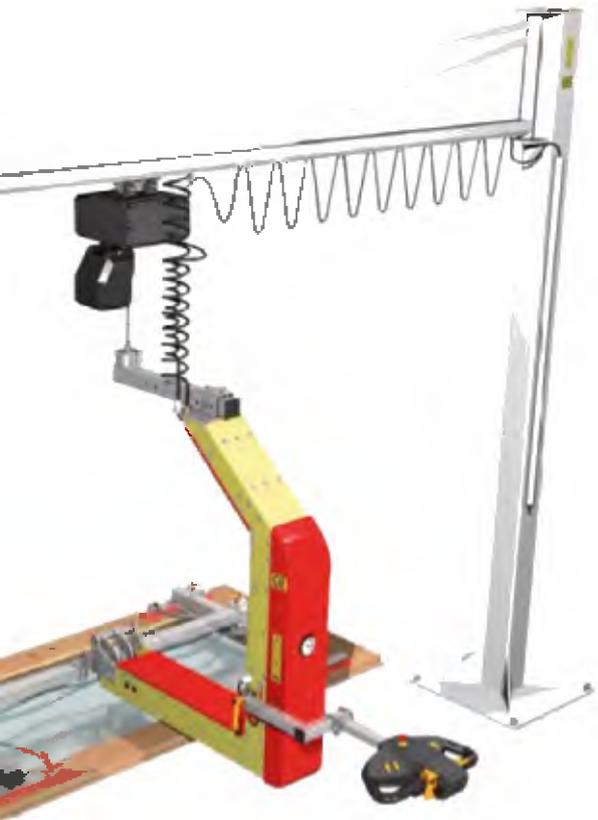

Also available as a rail system
with crane trolley



Technical specifications

	Vacuum lifer V-motion
Vacuum lifter	S
Fixed position 0° or 90°; not tiltable	
Max. load	150 kg
Max. lifting height	3 m
Column swing arm crane 4000	○
Wall mounted swing arm crane 4000	○
Arm length 6,000 mm instead of 4,000 mm	○
Smooth running rail system 6 m x 6 m	○
Smooth running rail system extension "x"/running metre	○
Height of the lower edge [UK]	approx. B-L
Overall height [B]	3.8/4.3/4.8/5.3/6.0 m
Height [L]	0.6/0.7/0.8 m
Distance [M]	200/255 mm
Swivel range [α]	125°
Pneumatic tilt function 0°-90°	○
Comfort operation	○
Thin panel lifting beam up to 150 kg	○
Heavy load lifting beam up to 250 kg	○
Safety package	○

S ... Standard equipment ○ ... Option - ... not available



Further information about the technical data, individual configuration options and all noise level values can be found on the internet at www.format-4.com

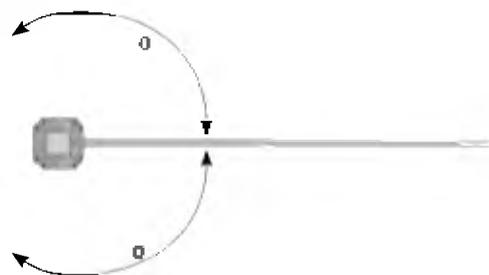
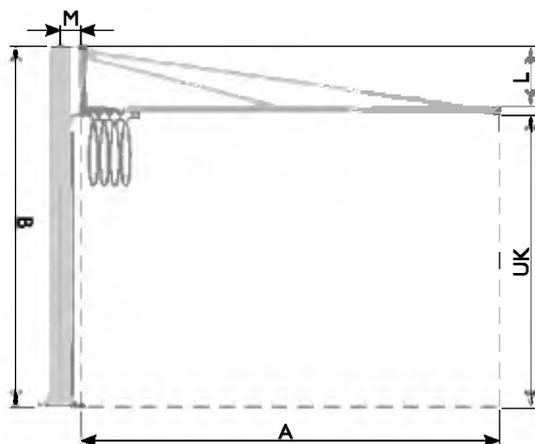

Symbolic image V-motion

Dimensions given can vary if special options are selected

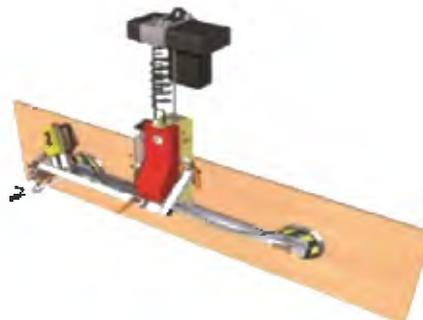

Vacuum lifter
Fixed position 0° or 90°; not tiltable



L-motion loading unit

Uninterrupted material flow
for maximum efficiency

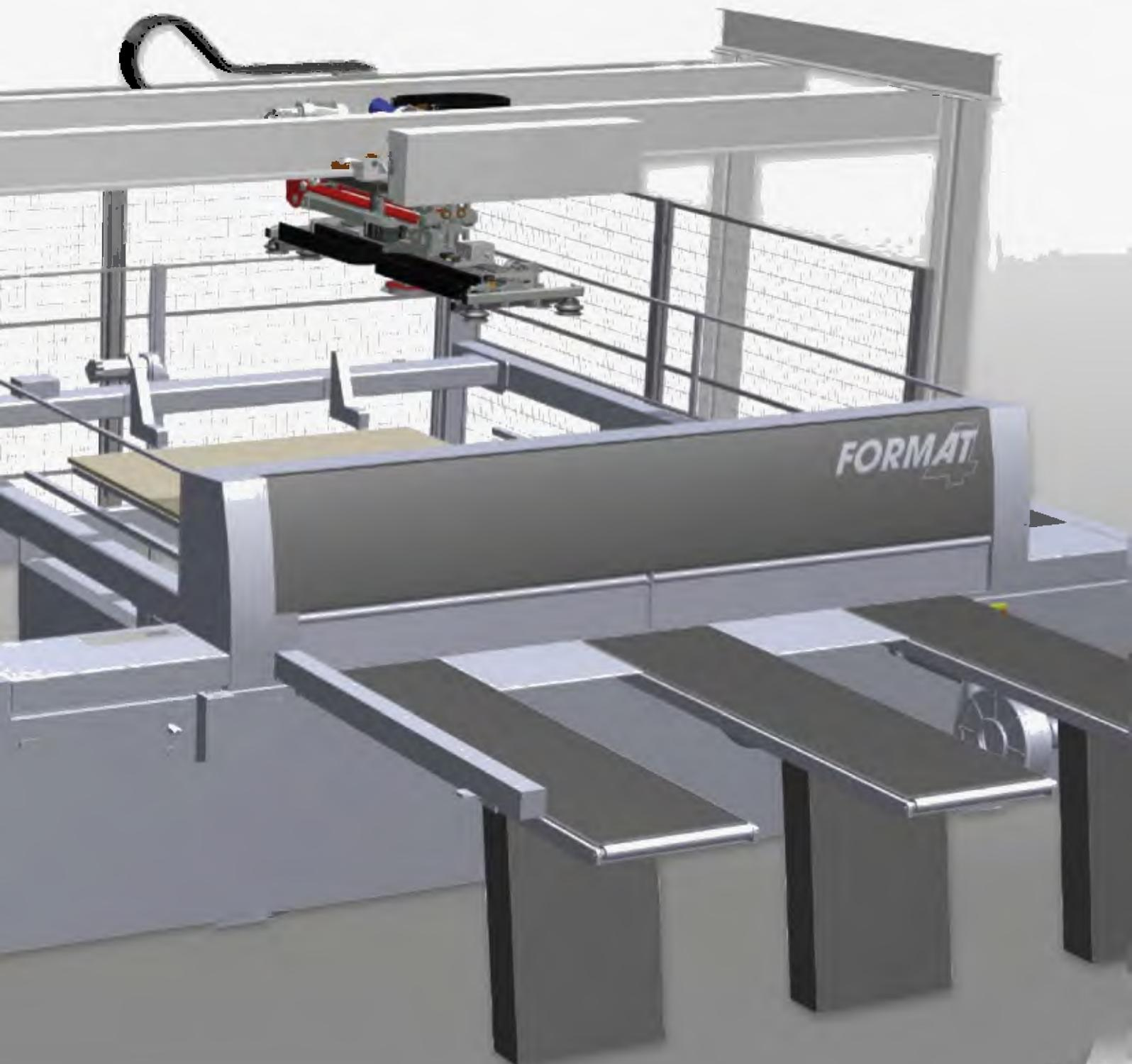

L-motion loading unit

The new Format-4 L-motion loading unit enables maximised production with single person operation. With cycle times of 15 seconds, the material flow in a linear system can be optimised and the full efficiency of the production capacity used to maximum advantage. The optional slewing gear positions the panels along and across the cutting direction, depending on the requirements of the user or the cutting optimisation software.

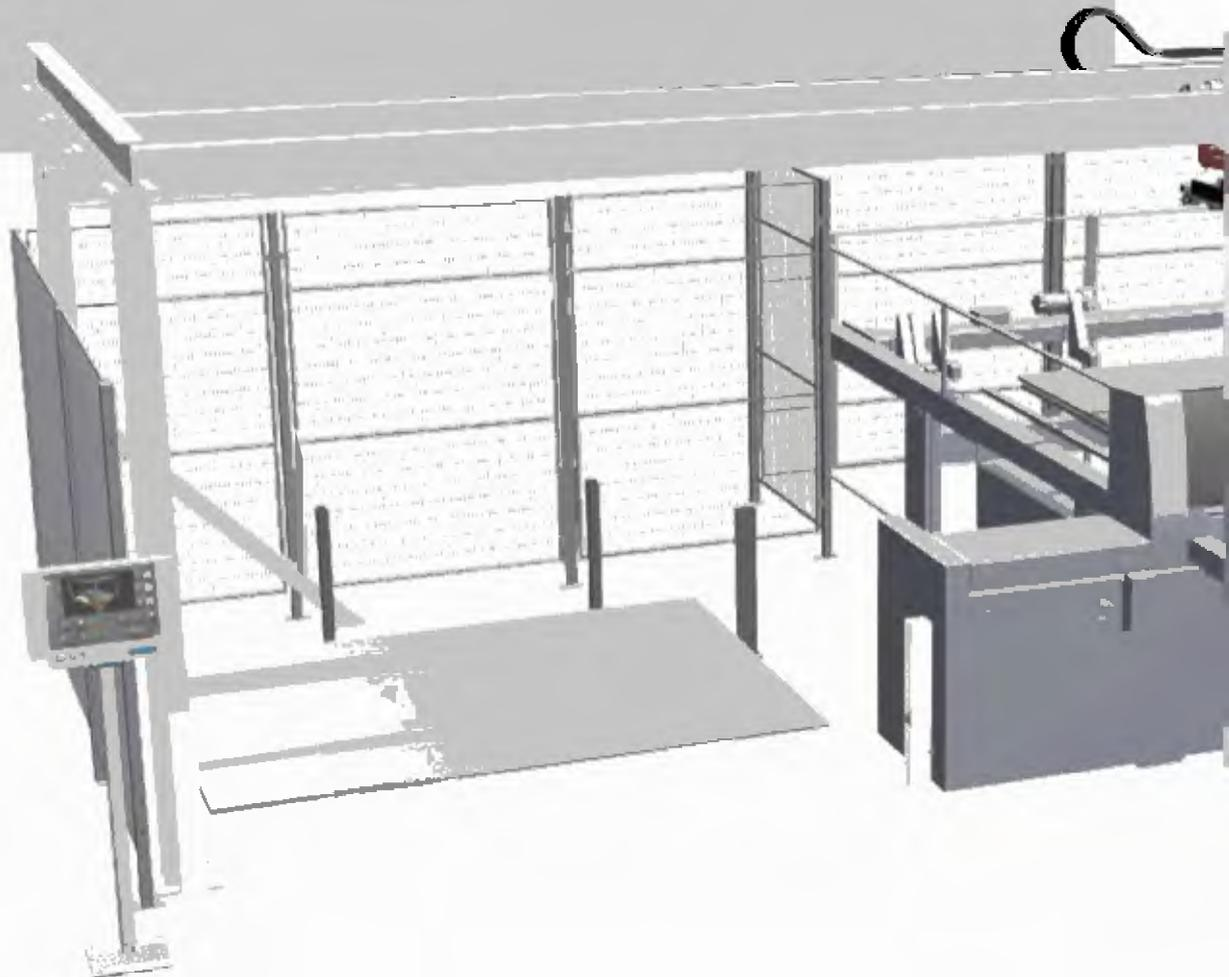

Loading system also available for the profit H08 and profit H10.

Your advantages at a glance:

- > Maximum productivity and reduced production costs with single person loading
- > The healthy workshop: Fatigue-free working, puts no strain on your back - fewer sick days
- > Surface neutral vacuum system - no more scratches!
- > Maximum flexibility - Free choice of the number and position of the stacks of the material

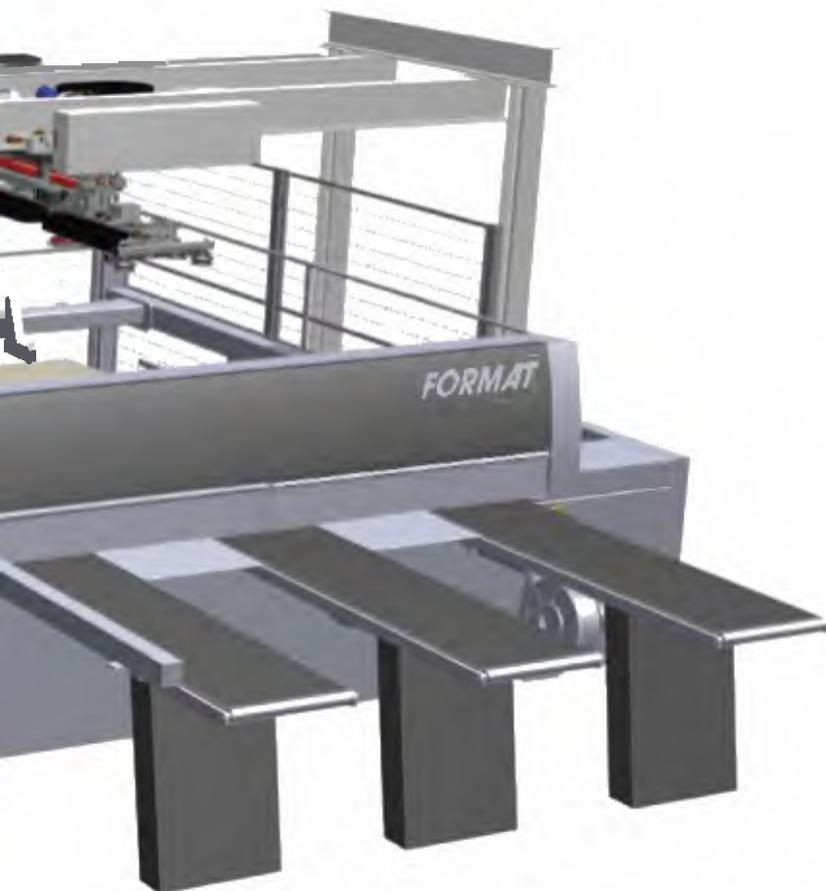

C-motion

The C-motion panel storage system offers an endless range of equipment and extension options for professional material handling.

We would be pleased to put together an individual offer for you.





Technical specifications

	L-motion panel storage
2 axes system	S
Travel speed x/z axis	80/25m/min.
Max. workpiece length	3,200 mm
Min. workpiece length	2,000 mm
Max. workpiece width	2,000 mm
Min. workpiece width	600 mm
Min. panel thickness	8 mm
Max. panel weight	200 kg
Max. stack height	1,800 mm
I stacking position selectable either to the left or right side	S
Additional stacking position	○
Rotating unit for workpieces	○
Vacuum beam with size adjustment	○
Stacking position at the rear instead of the side	○

S ... Standard equipment ○ ... Option - ... not available



Further information about the technical data, individual configuration options and all noise level values can be found on the internet at www.format-4.com

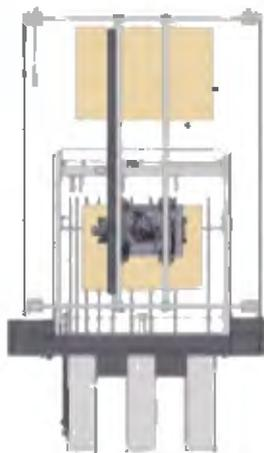

L-motion with I stacking position on the rear side

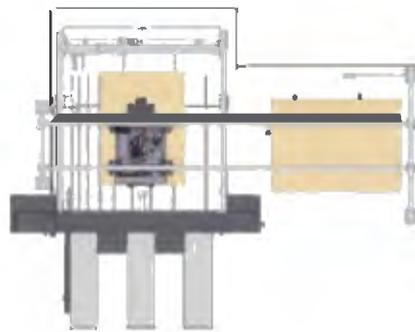

L-motion with I stacking position on the right side

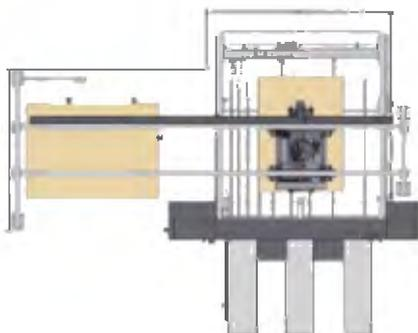

L-motion with I stacking position on the left side

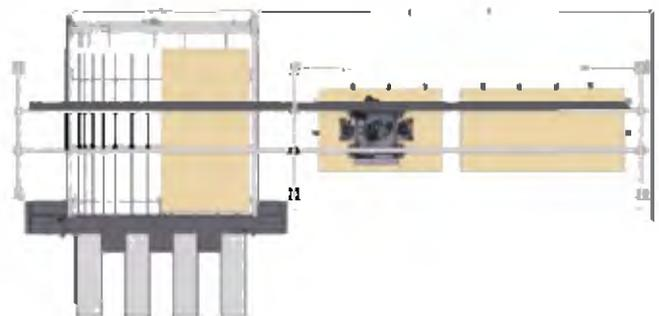

L-motion with 2 stacking positions on the right side

C-motion panel storage

Technical specifications available on request



HVP

Powerful, robust and versatile -
Heated veneer presses from FORMAT-4

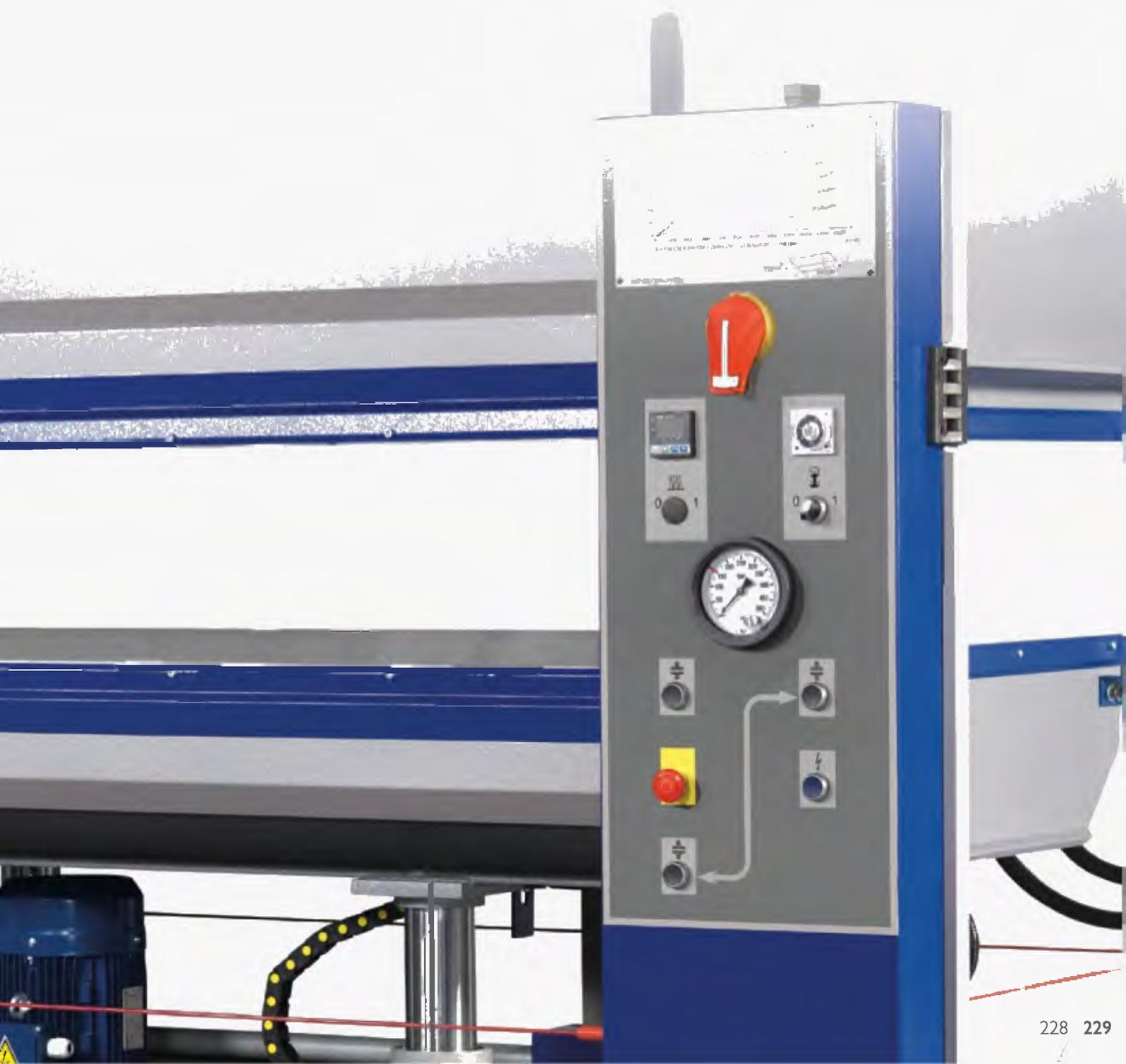

HVP

FORMAT

Heated veneer presses in every size and performance class

High quality veneer pressing with maximum possible efficiency - no problem with the new Heated Veneer Presses from Format-4.

Depending on the required use of the press, there are 5 different types to choose between, with up to 12 variations of each type.





Clear control panel

High process safety
with monitoring
of the lift

Increased productivity
through individually
adjustable height
settings



Control panel

Quick and simple use without separate programming or training. The pressure required can be read from the pressure table and set using the pressure regulator. No need for any complicated programming involving the length and width. A timer guarantees that the platen open after a preset pressing time. The opening width of the platen can also be set precisely.



Synchronised rack and pinion guide

The large dimensioned rail guides and torsionally rigid joints guarantee a parallel lift of the pressing platen.

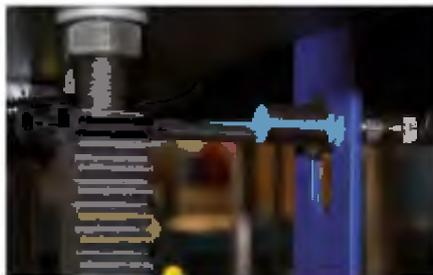

Sensor monitoring

Magnetic sensors monitor the parallel lift of the pressure platen and prevent uneven pressure build-up over the length of the platen.



Raised cylinder guide

By raising up the upper lip of the hydraulic cylinder casing, the cylinder is constantly laminated in oil. This prevents the cylinder seals from drying out and therefore extending their useable life.

ELKOM electric heating platen

The electrically heated platen have a thick aluminium plate on the pressing side, in which the heating coils are thermally encased. The encasing ensures an optimal heat flow in the direction of the pressing surface. For additional heat stabilisation there is another aluminium plate, which is also thermally insulated. These electric platen can be used up to a maximum working temperature of 120°C. As an option, the pressing surfaces can also be ordered with gold anodisation.

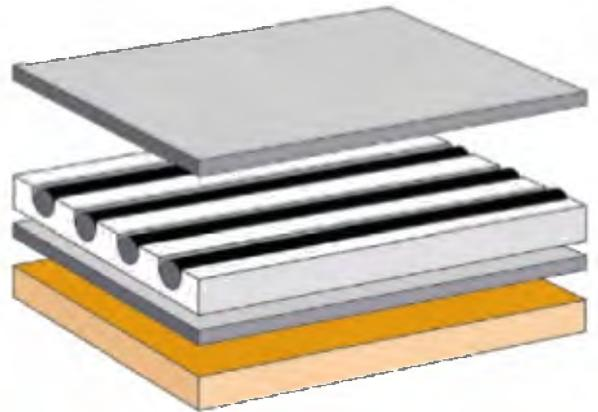

Shaped tube platen

The platen is built in a sandwich design. The core is covered above and below with solid steel platen. On the inside, a steel tube design forms the channels required to transport the water or oil and guarantees the stability required. The pressing surface is coated in aluminium and can as an option also be equipped with a Mylar film coating. With water, a maximum operating temperature of 90°C can be achieved. If oil is used as the heating medium, then a temperature of up to 120°C can be worked with.

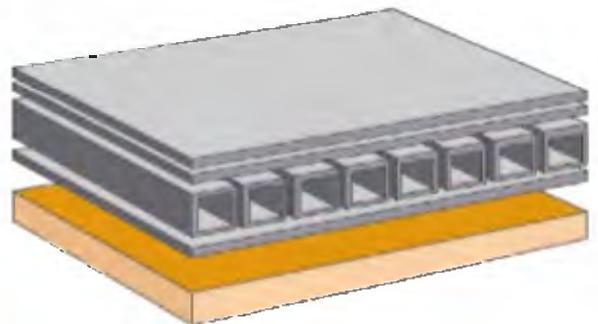

Solid drilled steel platen

The heating channels are drilled into a solid steel body, through which warm oil runs bringing the steel body to the operating temperature. This heavy duty design enables a maximum pressure of up to 40 kg/cm². The maximum operating temperature of these platen is 250°C.

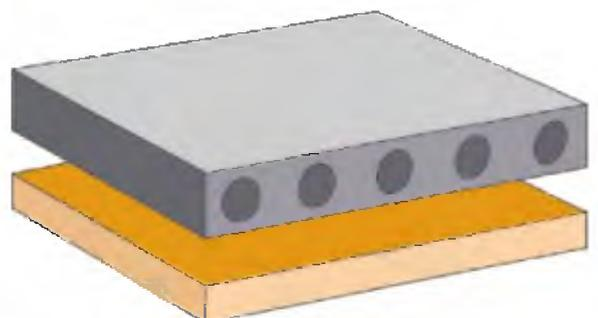

Technical specifications



	HVP 50	HVP 60	HVP 70L	HVP 90/90L/90XL
Press power	50 t	60 t	70 t	90 t
kg/cm ² (with 80% of the platen being used)	1.9	2.3	2.2	3.5/2.9/2.5
Heating platen length	2,500 mm	2,500 mm	3,000 mm	2,500/3,000/ 3,500 mm
Heating platen width	1,300 mm	1,300 mm	1,300 mm	1,300 mm
Stroke	400 (650)	400 (650)	400 (650)	400 (650)
Press cylinders (No.)	4	4	6	6
Press cylinder-Ø	70 mm	70 mm	70 mm	70 mm
Weight (depending on equipment, without packaging)	3,100– 3,700 kg	3,100– 4,500 kg	3,700– 5,200 kg	3,200–4,700 kg 3,700–5,400 kg 4,800–6,500 kg
Length [L]	3,100 mm	3,100 mm	3,700 mm	3,100/3,700/ 4,200 mm
Width [W]	1,600– 1,770 mm	1,600– 1,770 mm	1,600– 1,770 mm	1,600– 1,770 mm
Height [H]	1,800 (2,370) mm	2,000 (2,370) mm	2,000 (2,370) mm	2,000 (2,370) mm

Space requirement

Scale
1:50

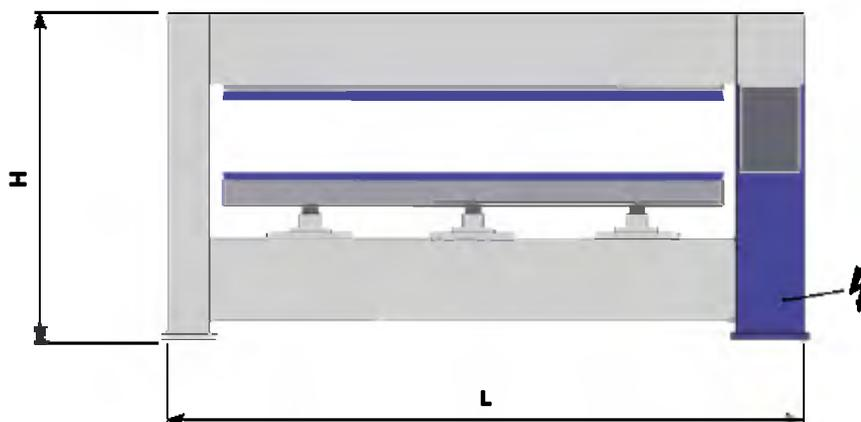

Symbolic image HVP

Dimensions given can vary if special options are selected

HVP 120/120L/120XL	HVP 160L	HVP 160XL	HVP 200XL
120 t	160 t	160 t	200 t
4.6/3.8/3.3	5.1	4.4	5.5
2,500/3,000/ 3,500 mm	3,000 mm	3,500 mm	3,500 mm
1,300 mm	1,300 mm	1,300 mm	1,300 mm
400 (650)	400 (650)	400 (650)	400 (650)
6	8	8	10
85 mm	85 mm	85 mm	85 mm
3,500–5,200 kg 4,000–5,700 kg 5,000–6,800 kg	4,300– 6,000 kg	5,500– 7,300 kg	7,800– 9,600 kg
3,100/3,700/ 4,200 mm	3,700 mm	4,200 mm	4,200 mm
1,600– 1,770 mm	1,600– 1,770 mm	1,600– 1,770 mm	1,600– 1,770 mm
2,000 (2,370) mm XL 2,100 (2,450) mm	2,100 (2,370) mm	2,200 (2,450) mm	2,200 (2,450) mm



Further information about the technical data, individual configuration options and all noise level values can be found on the internet at www.format-4.com

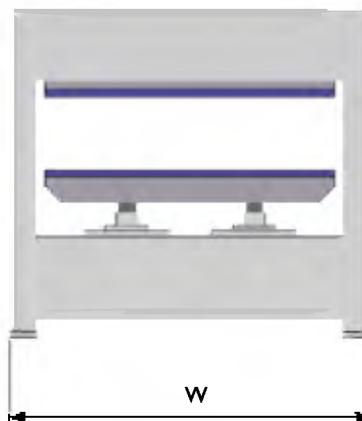

Visit us online and discover more about:

- Machines
- Videos
- Current promotions
- Tooling and accessories
- All technical information

www.format-4.com



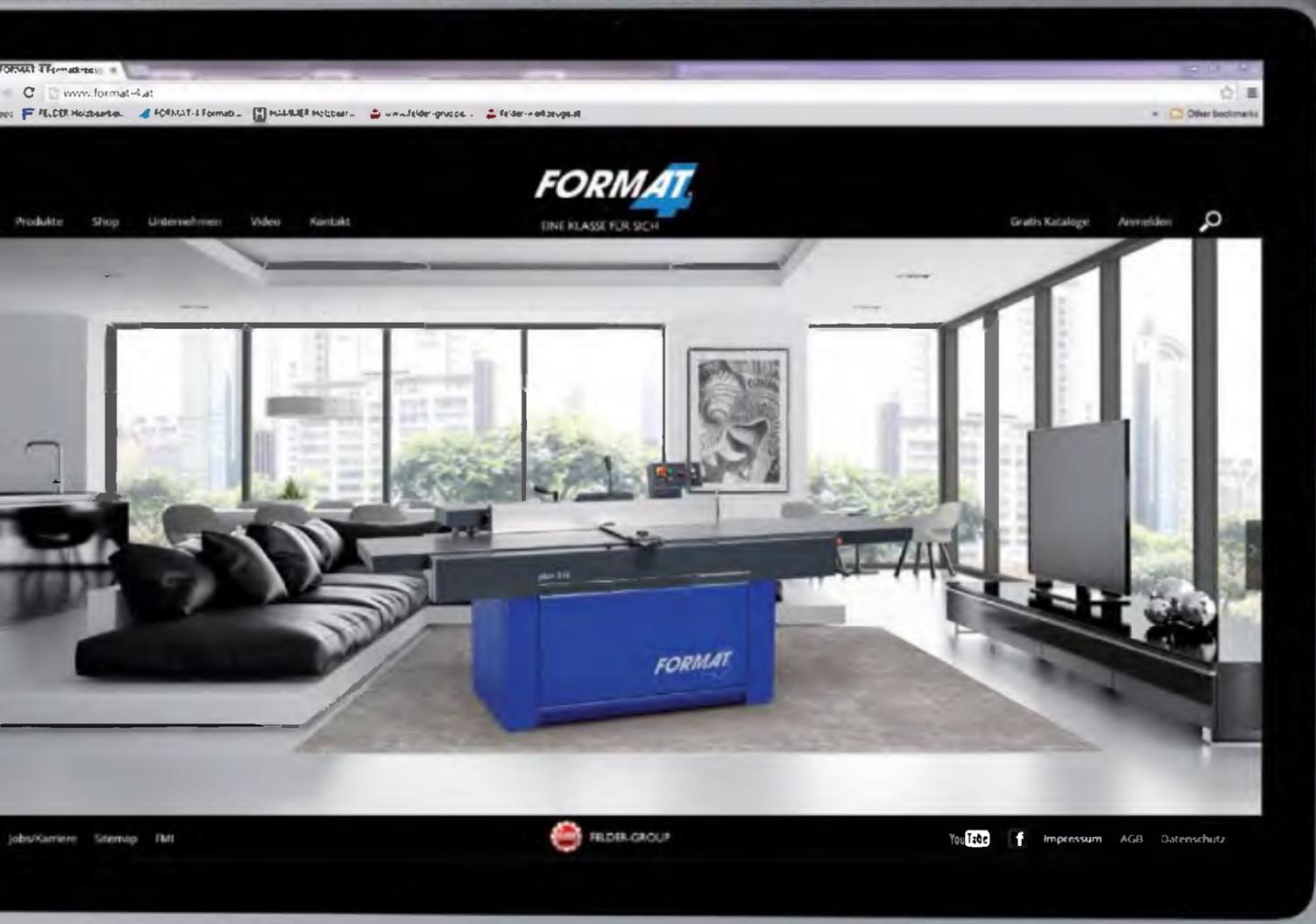



The Felder Group product range 2016

Sliding Table Saws



kappa 550 e-motion

kappa 550 x-motion

kappa 550

kappa 400 x-motion

kappa 400

K 940 S

Planers



plan 5 L

A 951 L

A 941

A3 41A

Thicknessers



exact 63

exact 51

D 963

D 951

A3 41D

Spindle Moulders



profil 45 M x-motion

profil 45 M

profil 45 Z x-motion

Saw Spindle Moulders



KF 700 S Professional

KF 700 Professional

KF 700

KF 500 Professional

KF 500

B3 perform

B3 winner

CNC Machining Centres



profit H500

profit H350

profit H300

profit H200

profit H10

profit H08

c-express 920 classic



G 360

G 330

G 320

G 220

FK 300

ForKa 300 S evo

ForKa 200 ECO

ERM 1050

Bandsaws



FB 940 RS
FB 740 RS

FB 940/840
FB 740/640

FB 710/610
FB 510

N4400
N3800

Heated Veneer Presses



HVP with Elkom®
electric heated platen

HVP with warm water
heater

HVP with thermal oil
heating

Dust extractors

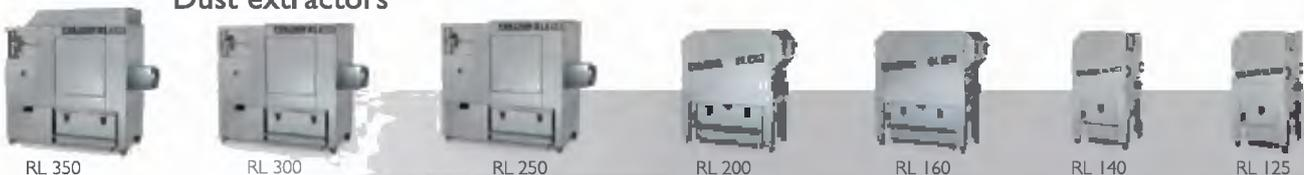

RL 350

RL 300

RL 250

RL 200

RL 160

RL 140

RL 125



K 700 S

K 700 Professional

K 700

K 500 S

K 500 Professional

K 500

K4 perform

K3 winner

Planer Thicknessers



dual 51

AD 981

AD 941

AD 741

AD 531

A3 41

A3 31



profil 45 Z

F 900 M

F 900 Z

F 703 M

F 700 Z

F 500 MS

F 500 M

F3

Combination Machines



CF 741 S Professional

CF 741 Professional

CF 741

CF 531 Professional

CF 531

C3 31 perform

C3 31

Edgebanders



tempora 60.12 x-motion plus/e-motion

tempora 60.08 x-motion plus

G 680

G 670

G 660

G 500

G 480

Wide Belt Sanders



finish 1350 classic/gloss

finish 1302/1102

FW 1102/1100

FW 1102/950 classic

Brushing machine



structura 60.02

Stroke Sander



FS 722

Beam Saws



kappa automatic 60/80/100

kappa V60

Drilling Machines



FD 21

FD 250

F31

Edge Sanders

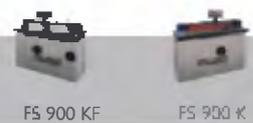

FS 900 KF

FS 900 K

Briquetting Presses



AF 22

AF 18

AF 14

AF 12

S 61

FBP 50

FBP 60

FBP 70





FORMAT-4 Austria

KR-Felder-Straße 1

6060 HALL in Tirol

Austria

Tel. +43 (0) 52 23 55 306

Fax +43 (0) 52 23 55 306-63

E-Mail: info@format-4.com

www.format-4.com

Immediate-Info:

 Tel. 01908 635000

Fax 01908 307000

www.format-4.co.uk

A/16F4-09-EUK/S/1.00/V/2710



PM/JB · © 01/2016 · FELDER® Austria

The machines are occasionally pictured with optional equipment.
Prices and specifications are subject to changes without notice.